

**THIS MANUAL INCLUDES FEATURES WHICH ARE ONLY AVAILABLE IN CONTROL PANEL
FIRMWARE VERSION 20 OR LATER.**

CHANGES FROM PREVIOUS EDITION

The following changes have been made to this manual (WI818D) since the last edition (WI818C).

New GEM-P3200 Version 20 Features:

- ✓ New Easy Menu Programming allows the system to be completely programmed through Menu Driven Easy Program Mode. Requires the use of the following version keypads:
 - GEM-RP1CAe2, Version 6
 - GEM-RP2ASe2, Version 5b
 - GEM-RP3DGTL, Version 1c
- ✓ Maximum Wireless Zones expanded from 32 to 48
- ✓ Maximum Number of Users expanded from 32 to 48
- ✓ Chime 2 zone provides second distinct pulsating "Chime Zone" tone
- ✓ Set System Time and Date in User Program Mode
- ✓ System Trouble Audible Automatic Timeout
- ✓ Inhibit System Trouble Audible
- ✓ Easy Programming of PC Preset Auto download ID and Callback Numbers
- ✓ Support of GEM-PRINT module
- ✓ Cancel Reporting Code
- ✓ Wireless Trouble Reporting by Zone
- ✓ Pager (Telco 3) Reporting Delay
- ✓ Pager - Programmable Number of Reports of Same Signal
- ✓ Pager - Maximum Number of Consecutive Pages
- ✓ Specific Logging of Communication Failure Modes
- ✓ New Relay Event "Area Disarmed" (PCD3000 programmable only)
- ✓ Programmable DST start date (PCD3000 programmable only)
- ✓ 20 Digit Dialing Prefix

Upon entering program mode, the keypad display will flash the control panel firmware version, followed by the keypad firmware version:
GEM-RP1CAe2: [2006], GEM-RP2ASe2: [205b], GEM-RP3DGTL: [20/1C]

NOTE: Typically, any version GEM-P3200 control panel could be upgraded to the latest firmware by replacing the EPROM with a newer version. This is no longer the case. The Firmware Version 20 EPROM must only be used in a Version 18 (or greater) PCBoard. Do NOT attempt to upgrade a GEM-P3200 control panel which currently is running Firmware Version 11C (or prior) to version 20 (or greater) by replacing the EPROM.

The PCBoard version (triangle number) is printed on a triangular shaped sticker affixed to the GEM-P3200 circuit board.



NAPCO Security Systems, Inc.
333 Bayview Avenue, Amityville, New York 11701
For Sales and Repairs, call toll free: (800) 645-9445
For direct line to Technical Service, call toll free: (800) 645-9440
Internet: <http://www.napcosecurity.com>

TABLE OF CONTENTS

SYSTEM PROGRAMMING OPTIONS	4	PROGRAMMING OPTIONS & WORKSHEETS	34
<i>Introduction</i>	<i>4</i>	<i>System Delays (Addr 0000-0002, 2402, 2406 & 2414)</i>	<i>35</i>
<i>Downloading from a Computer</i>	<i>4</i>	<i>System Delays (Addr 2407, 2408 & 4088)</i>	<i>35</i>
EASY MENU DRIVEN PROGRAM MODE.....	5	<i>System Delays (Addr 2400, 2401, 2403-2405 & 4083)</i>	<i>36</i>
<i>Dealer Program - Preliminary Information</i>	<i>5</i>	<i>Keypad System Codes (Addr 0490, 0495 & 0500).....</i>	<i>36</i>
<i>Accessing Dealer Program Mode</i>	<i>5</i>	<i>CS Receiver Opt. (Addr 0520, 0521, 0525, 0526, 0550, 0551, 0575 & 0576).....</i>	<i>37</i>
<i>Customizing a Default Program</i>	<i>5</i>	<i>CS Receiver Tel. Numbers (Addr 0527-0546, 0552-0571, 0577-0596)</i>	<i>38</i>
GEM-RP1CAe2 KEYPAD	6	<i>Download/Callback Options (Addr 4089, 0600-0619, 0625-0647, 1022 & 1023).....</i>	<i>38</i>
<i>Number of Zones & Keypads per Area</i>	<i>6</i>	<i>CS Subscriber ID Numbers (Addr 0650-0857).....</i>	<i>39</i>
<i>Local or Central Station Reporting System.....</i>	<i>6</i>	<i>CS Reporting Codes (Addr 0860-0869)</i>	<i>40</i>
<i>Central Station Receiver 1 Tel. Number</i>	<i>7</i>	<i>CS Reporting Codes (Addr 0870-0904)</i>	<i>41</i>
<i>Central Station Receiver 1 Account Number.....</i>	<i>7</i>	<i>CS Area & System Reporting Opt. (Addr 1024-1027) .</i>	<i>41</i>
<i>Central Station Receiver 1 Format</i>	<i>8</i>	<i>CS Zone Reporting Codes (Addr 0910-0957)</i>	<i>42</i>
<i>Enter User Codes</i>	<i>9</i>	<i>CS User Reporting Codes (Addr 1030-1081).....</i>	<i>43</i>
<i>RF Transmitter Points.....</i>	<i>11</i>	<i>Global System Trbl. Reporting Opt. (Addr 1082-1116).....</i>	<i>45</i>
<i>Key Fob Transmitters</i>	<i>12</i>	<i>Area System Trbl. Reporting Opt. (Addr 1120-1137) ..</i>	<i>46</i>
<i>Enter Zone Descriptions</i>	<i>12</i>	<i>Zones 1-48 Options (Addr 1200-1786).....</i>	<i>47</i>
<i>Enter Date.....</i>	<i>12</i>	<i>System Options (Addr 2415-2419).....</i>	<i>51</i>
<i>Enter Time</i>	<i>13</i>	<i>System Options (Addr 2420-2422 & 4084).....</i>	<i>52</i>
<i>Enter Dealer Code</i>	<i>13</i>	<i>Keypad Options (Addr 2425-2454).....</i>	<i>54</i>
<i>Clear Dealer Program.....</i>	<i>13</i>	<i>User Area Options (Addr 2500-2547).....</i>	<i>55</i>
GEM-RP2ASe2 KEYPAD	14	<i>EZM Group Options (Addr 2600-2627)</i>	<i>56</i>
<i>Number of Zones & Keypads per Area</i>	<i>14</i>	<i>Area Arming Options (Addr 2650-2651)</i>	<i>57</i>
<i>Local or Central Station Reporting System.....</i>	<i>15</i>	<i>Remote Access Logging (Addr 3184).....</i>	<i>57</i>
<i>Central Station Receiver 1 Tel. Number</i>	<i>16</i>	<i>Area Output Control Options (Addr 2700-2733).....</i>	<i>58</i>
<i>Central Station Receiver 1 Account Number.....</i>	<i>16</i>	<i>RF Rcvrs. & Sup. Timers (Addr 3776 & 3760-3775) ...</i>	<i>59</i>
<i>Central Station Receiver 1 Format</i>	<i>16</i>	<i>System Reset Features (Addr 4091-4093).....</i>	<i>60</i>
<i>Enter User Codes</i>	<i>17</i>	USER PROGRAM MODE	61
<i>RF Transmitter Points.....</i>	<i>19</i>	<i>Preliminary Information.....</i>	<i>61</i>
<i>Key Fob Transmitters</i>	<i>20</i>	<i>Accessing User Program Mode.....</i>	<i>61</i>
<i>Enter Date.....</i>	<i>21</i>	<i>User Codes.....</i>	<i>61</i>
<i>Enter Time</i>	<i>21</i>	<i>Zone Descriptions.....</i>	<i>62</i>
<i>Enter Dealer Code</i>	<i>21</i>	KEYPAD CONFIGURATION MODE.....	63
<i>Enter Dealer Program.....</i>	<i>21</i>	<i>Keypad Installation</i>	<i>63</i>
GEM-RP3DGTL KEYPAD	22	<i>Configuring the Keypads</i>	<i>63</i>
DIRECT ADDRESS PROGRAM MODE.....	29	KEYPAD PROGRAMMING MODES	66
<i>Keypad Programming Overview</i>	<i>29</i>	PROGRAMMING OPTIONS INDEX	71
<i>Accessing Direct Address Program Mode</i>	<i>29</i>	GEM-P3200 WIRING DIAGRAM	75
<i>What You See on the Keypad.....</i>	<i>30</i>		
<i>Direct Address Program Mode Keypad Commands.....</i>	<i>30</i>		
<i>Programming Overview</i>	<i>32</i>		
<i>Direct Address Programming Example.....</i>	<i>33</i>		

Refer to accompanying GEM-P3200 Installation Instructions (WI817) for installation information.

NOTE: THESE INSTRUCTIONS ARE INTENDED AND WRITTEN FOR PROFESSIONAL INSTALLATION PERSONNEL HAVING SUITABLE TRAINING, EXPERIENCE AND INSTALLATION EQUIPMENT. IT IS RECOMMENDED THAT AFTER PROGRAMMING, THE ERROR CHECK UTILITY OF THE PCD3000 DOWNLOADER BE USED TO VERIFY THAT THE CONTROL PANEL PROGRAM CONTAINS NO ERRORS OR CONFLICTS WHICH MAY INHIBIT ITS INTENDED OPERATION.



SYSTEM PROGRAMMING OPTIONS

INTRODUCTION

The GEM-P3200 control panel may be programmed by various means, each of which will be covered in detail in the sections that follow. Keypad displays shown first are for a GEM-RP1CAe2 (Version 6), the recommended keypad for programming, then for the GEM-RP2ASe2. The GEM-RP2ASe2 keypad functions similarly; however, because of its reduced display capabilities, messages are abbreviated and will scroll through two or more screens. Zone descriptions cannot be programmed using a GEM-RP2ASe2 keypad.

- ✓ **Downloading From a Computer.** This is the preferred method. The panel may be downloaded from (or uploaded to) an IBM PC-compatible computer, with a 386 (or higher) microprocessor, either locally or remotely. NAPCO's PCD3000 Quickloader software, Version Update 3.34 or later features context-sensitive help screens as well as an error-checking utility that prevents programming of incompatible or conflicting data to ensure proper panel operation.
- ✓ **Easy Menu Driven Program (Dealer Program) Mode - Keypad Programming.** The Easy Menu Driven Program Mode allows keypad programming of number of zones in area 1, number of zones in area 2, fire zone numbers (both 4-wire and 2-wire), central station reporting, entry/exit zone numbers, interior zone numbers, number of keypads in area 1, number of keypads in area 2, central station telephone number, central station account number, auto download id number & PC preset callback telephone number, central station receiver format, user codes, RF transmitter points, RF key fob transmitters, zone descriptions, date and time. For new panels, a custom default program may be created at the keypad. A menu-driven utility prompts the installer to configure the system. Further detailed customization is done in the Direct Address Program Mode.
- ✓ **Direct Address (Dealer Program) Program Mode - Keypad Programming.** The Direct Address Program Mode is an extension of the Dealer Program Mode wherein data is entered at the keypad by location. This mode is accessed from the Easy Menu Driven Program Mode by pressing the **RESET** button at any time.
- ✓ **User Program Mode - Keypad programming.** The User Program Mode is intended for authorized users and is limited to keypad programming of User Codes, Zone Descriptions, Time and Date.

DOWNLOADING FROM A COMPUTER

The control-panel program may be downloaded from the computer by either of the following methods.



Local Downloading

(**Note:** This procedure should be used after installation, after peripheral devices are connected.)

For a direct high-speed data transfer to the control panel from a desktop computer, connect the download jack (J1) on the panel to the LOCAL jack (J3) on the Napco PCI2000/3000 computer interface using the supplied 6-conductor cable. (Refer to PCI2000/3000 Installation Instructions WI443 for wiring diagram and procedures.)

Similarly, a high-speed local download may be made in the field using a notebook or laptop computer. Connect J1 on the control panel to a Napco PCI-MINI computer interface using the 6-conductor cable supplied. (Refer to PCI-MINI Installation Instructions WI767.)

Remote Downloading

(Also see PCI2000/3000 Installation Instructions WI443.)



Function Mode. During this procedure, voice contact will be lost, therefore both the installer and the computer operator should be familiar with the operation. When a steady high-pitched tone is heard at the site phone, access the "ACTIVATE DOWNLOAD" Function (see Keypad Programming Modes), then press the **ON** button or the YES (**INTERIOR**) button; the site phone will go dead. Hang up the phone and wait for a call from the central station confirming a successful download.

Callback Method. An installed, unattended panel may be programmed or reprogrammed remotely using the Callback-Method Download feature of the PCD3000 software. Remote downloading requires a modem compatible with the PCI2000/3000. Upon answering the call from the computer, the panel will verify the Download Security Code and, if confirmed, will establish a connection. If a Callback Number is programmed into the panel, the panel will automatically disconnect and call the computer at this number before establishing a connection. The panel can support two Callback Numbers to allow downloads from two different offices.

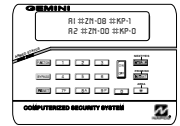
EASY MENU DRIVEN PROGRAM MODE





DEALER PROGRAM - PRELIMINARY INFORMATION

- ☞ Only Keypad #1 may be used for both dealer and user programming, however this keypad may be located in any area.
- ☞ The Master Security Code is *printed on the panel's microprocessor can*. Use this code to enter the Dealer Program Mode to program a custom Dealer Security Code. Record the number, then remove the code label to prevent unauthorized access to the panel. If you forget your Dealer Security Code, use the Master Security Code to enter programming.
- ☞ After entering codes or data, press the save  button. Data will not be stored into memory unless it is pressed.
- ☞ If the keypad is in the Program Mode and no activity is detected for longer than 4 minutes, a steady tone will sound. Silence the sounder by pressing the  button to continue, or by pressing the  button to exit.
- ☞ A panel that has been COLD STARTED (Address Location 4093) performs identically to a new panel.
- ☞ When programming more than 2 areas, Direct Address Programming Mode must be used to complete the program.

KEYPAD #1: For ease of programming, it is recommended that a GEM-RP1CAe2 (Version 6) be used as Keypad #1. (Regardless of which keypad is selected, all *new* keypads are configured as Keypad #1 out of the box.)



If a GEM-RP2ASe2 (Version 5b) is used, configure address jumpers as Keypad #1 (see Configuring the GEM-RP2ASe2 Keypad.).

ACCESSING DEALER PROGRAM MODE

1. Press  
← Master Security Code (on microshield) →

2. Press  **Until "ACTIVATE PROGRAM Y/N" (GEM-RP1CAe2), "TURNON PROG Y/N" (GEM-RP2ASe2) or "1" (GEM-RP3DGTL) appears on the keypad display.**

3. Press  **To Enter Dealer Program Mode.**

4. Press   **To Exit Dealer Program Mode when finished.**

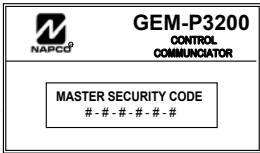



CUSTOMIZING A DEFAULT PROGRAM

For any new panel, you can design a default program that will best suit your application. Using this procedure, you will configure the panel for:

- | | | |
|---|---------------------------------------|------------------------|
| ✓ Number of Zones in Area 1 | ✓ Number of Keypads in Area 2 | ✓ Key Fob Transmitters |
| ✓ Number of Zones in Area 2 | ✓ CS Receiver 1 Telephone Number | ✓ Zone Descriptions * |
| ✓ Fire Zones | ✓ Auto Download ID Number & PC Preset | ✓ Date * |
| ✓ 2-Wire Fire Zones | ✓ Callback Telephone Number | ✓ Time * |
| ✓ Local System or Central Station Reporting | ✓ CS Receiver 1 Account Number | ✓ Dealer Code |
| ✓ Exit/Entry Zones | ✓ CS Receiver 1 Format | |
| ✓ Interior Zones | ✓ User Codes | |
| ✓ Number of Keypads in Area 1 | ✓ RF Transmitter Points | |
- * NOTE: GEM-RP1CAe2 Keypad Only

This procedure will automatically set up system keypads, EZMs, wireless transmitters, etc. After your basic default program has been loaded, you may alter it as necessary in the Direct Address Program Mode.

NEW PANELS: The custom default program may be created for new panels only. Once the panel has been programmed by any means, the number of areas, number of zones, fire zones, entry/exit zones and interior zones will be suppressed and cannot be changed. Should it be necessary to create a new custom default program, (a) from the Dealer Program Mode, press the  button to enter the Direct Address Program Mode; (b) access Location 4091 (Clear Program); (c) press the  button and start over.



A. GEM-RP1CAe2 Keypad

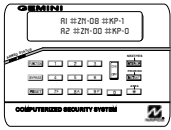

To create your customized default program using a GEM-RP1CAe2 keypad, enter the following parameters. In each of the following steps, press the **FUNCTION** button to set cursor, the NEXT (**INTERIOR**) button to go forwards, the PRIOR (**INSTANT**) button to go backwards, the **ON/OFF** button to save and the **RESET** button twice to exit at any time.

```
#OF ZNS IN AREA1
ENTER # ZONES 08
```

(Direct Entry)

```
#OF ZNS IN AREA2
ENTER # ZONES 00
```

(Direct Entry)

Total Number of Zones in Area 1 & Area 2 (*Appears for New Panel Only*)
Directly enter the total number of zones to be programmed for Area 1 and Area 2, respectively. Valid entries are from 01 to 48. Directly enter the total number of zones, including leading zeros. Use number buttons **1** through **9P**. **NOTE:** Press the **0** button for a zero. The system is based on groups of 4 zones each (after the first 8 zones), and will automatically round up to the next group of 4. For example, if you enter 18, it will automatically convert this to 20 zones. Press **ON/OFF** to save. Press NEXT (**INTERIOR**) button to proceed.

Note: The GEM-P3200 is limited to a combined maximum of 48 zones and 7 keypads. All 48 zones and 7 keypads may be programmed in the EZ Program Mode. For more options, see Zone and Keypad Options in Direct Address Programming.

```
FIRE ZONES
ENTER ZONE # 00
```

(Direct Entry)

Fire Zones (*Appears for New Panel Only*)
Enter the zone number of any Fire Zones (both 2-wire, 4-wire or wireless). Valid entries are from 01 to 48. Directly enter each zone number, including leading zeros, and press **ON/OFF** to save, and then repeat for any additional zone(s). Press NEXT (**INTERIOR**) button to proceed.

NOTE: If you are programming a 2 Area system, enter the zone number of zones required for Areas 1 & 2. All fire zones are common to areas 1 and 2. The Direct Address Program Mode can then be used to customize them as needed. See Zone Options.

```
2-WIRE FIRE ZNS
ENTER ZONE # 00
```

(Direct Entry)

2-Wire Fire Zones (*Appears for New Panel Only*)
Enter the zone number of any Fire Zones (from previous question) which are to be used with 2-wire smoke detectors. The only valid entries are 07 and 08. Directly enter each zone number, including leading zeros. Press **ON/OFF** to save, and then repeat for any additional zone(s). **NOTE:** Only zones which

have been designated as Fire Zones can be programmed as 2 Wire Fire zones. Press NEXT (**INTERIOR**) button to proceed.

NOTE: JP7 must be set to "2-WF" position for 2-wire fire zones 7 and 8 (refer to Installation Instructions).

```
REPORT ALL ZONES
TO CENTRAL? Y/N
```





(Press YES or NO)

Local System or C.S. Reporting System (*Appears for New Panel Only*)
Press YES (**INTERIOR**) button for all zones to report; press NO (**INSTANT**) button for no zones to report (LOCAL SYSTEM).

EXIT/ENTRY ZONES
ENTER ZONE # 00

(Direct Entry)

Exit/Entry Zones (Appears for New Panel Only)





Directly enter the zone numbers which are to be used as Exit/Entry zones. Valid entries are from 01 to 48. Directly enter each zone number, including leading zeros. Use number buttons  through . **NOTE:** Press the  button for a zero. Press  to save and then repeat for any additional zone(s). Press NEXT () button to proceed.

NOTE: Exit/Entry Zones will have an entry delay of 30 seconds and an exit delay of 60 seconds. Chime will automatically be programmed for all E/E zones. If you are programming a 2 Area system, enter all of the zones required for Areas 1 & 2.

INTERIOR ZONES
ENTER ZONE # 00

(Direct Entry)

Interior Zones (Appears for New Panel Only)





Directly enter the zone numbers which are to be used as Interior Zones. Valid entries are from 01 to 48. Directly enter each zone number, including leading zeros. Use number buttons  through . **NOTE:** Press the  button for a zero. Press  to save and then repeat for any additional zone(s). Press NEXT () button to proceed.

NOTE: All Interior zones will also be automatically programmed as "Exit/Entry Follower" zones. If you are programming a 2 Area system, enter all the zones required for Areas 1 & 2.

AREA 1 KEYPADS
ENTER #KPS 01

(Direct Entry)

Number of Keypads in Area 1

Directly enter the total number of Keypads to be installed in Area 1. Valid entries are from 01 to 07. Directly enter the number of keypads, including leading zeros. Use number buttons  through . **NOTE:** Press the  button for a zero. Press  to save. Press NEXT () to proceed.

AREA 2 KEYPADS
ENTER #KPS 00

(Direct Entry)









Number of Keypads in Area 2



Directly enter the total number of Keypads to be installed in Area 2. Valid entries are from 01 to 07.

CENTRAL PHONE #

(Direct Entry)

Central Station Receiver 1 Telephone Number

Using number buttons, enter telephone number of up to 16 digits including prefix letters, if necessary, for receiver 1. Use number buttons  through  for digits 1–9; press the   button for a zero and   through   for letters B–F, respectively. **NOTE:** Pre-Dial

Delay = "D"; Dial-Tone Detection = "E". Pressing the  button will produce a blank space (•). Press  to save. Press NEXT () button to proceed. **NOTE:** Central Station Receiver 2 and 3 Telephone Numbers can only be entered in Direct Address Programming. See CS Receiver Options.

Easy Programming of Auto download ID #'s and PC Preset Callback Numbers (GEM-RP1CAe2 only)

For unattended PC Preset downloading, it is now possible to set the Auto download ID #'s and PC Preset Callback from the Keypad Easy Program Mode.

- At the field for CENTRAL PHONE #, program an "F" followed by the Auto Download ID # (2 digits) and then the Callback Telco # (up to 13 digits).
- Press [ON/OFF] to save.
- Exit Program Mode ([RESET] [RESET]).
- Enter Master Code
- Press [FUNCTION]
- Go to Function "ACTIVATE DOWNLOAD Y/N" and press YES (INTERIOR).
- The panel will automatically call the PC Preset computer and download the program on the specified Auto Download line # of PC Preset.

CENTRAL PHONE #
F0715168429400

Example: Program an Auto download ID # of 07 and a PC Preset Callback # of 1-516-842-9400

- Go to Central Phone # input screen and press: [*] [5] [0] [7] [1] [5] [1] [6] [8] [4] [2] [9] [4] [0] [0] [ON/OFF]



CENTRAL STATION
ACCOUNT # { ____ }

(Direct Entry)

Central Station Receiver 1 Account Number

Enter an account number of up to four digits. Use number buttons through for digits 1–9. **NOTE:** Press the button for a zero and press the buttons for a blank space (*). through for letters B–F, respectively. Press to save . Press NEXT () button to proceed.

NOTE: Central Station Receiver 2 and 3 Account Numbers can only be entered in Direct Address Programming. See CS Reporting Options.

SEE WI FOR INFO
RCVR FORMAT {0}

(Direct Entry)

Central Station Receiver 1 Format

From the table below, enter the central station's receiver format. Use number buttons through . **NOTE:** Press the button for a zero. and press the buttons for a blank space (*). Press through for letters B–E, respectively. Press to save. Press NEXT () button to proceed.

DATA ENTRY	CS RECEIVER 1 FORMAT
blank(*)	Ademco Slow, Silent Knight Slow
1	Sescoa, Vertex, DCI, Franklin Fast
2	Radionics Fast
3	Silent Knight Fast
4	Radionics, DCI, Franklin Slow
5	Universal High Speed
8	Radionics BFSK

DATA ENTRY	CS RECEIVER 1 FORMAT
9	FBI 4/3/1
0	Radionics Modem 2
B	SIA
C	Ademco Point ID
D	Ademco Express
E	Pager

NOTE: Modem IIe is available only in Direct Address Programming. Central Station Receiver 2 and 3 Formats can only be entered in Direct Address Programming. See CS Receiver Options.

ENTER USER CODE















U01 123 ___ -F3 - ___

User# User Code Option /Level Access Control

Enter User Codes (Press the  button to set cursor.)

Enter up to 48 User Codes with User Options, Authority Level and Access Control Options (if necessary) for each code. Refer to the tables below and on the next page for available data entries for User Options, Authority Level and Access Control Options. **Note:** All 48 Users must be assigned to areas in "Enable User Code by Area" (Address 2500-2547) in Direct Address Programming. By default, only User 1 is enabled in Area 1 and Area 2.

User 2 - 8 are enabled in Area 1 and user 9 - 16 are enabled in Area 2.

-  Press the  button to set the cursor to the User Code. Use the number buttons  through  to enter a code of up to 6 digits. Enter up to 6 digits (4 digits is recommended) in the first six boxes from left to right for each user code. Valid entries are: 0-9. **Note:** Press the  button for a zero. No blank spaces in between; leave blank (•) any trailing boxes. If an "Ambush Code" (Address 0495) is entered, *do not* program the first two digits of ANY User Code as the same digits entered for the "Ambush Code".
-  If the programmed code is less than 6 digits, press the  button to set the cursor to the OPTION/LEVEL. Refer to the tables below for the available User Option and User Level data entries. Enter the user options data in the left digit. Enter the level data (with arming options, if any, added) in the right digit. **Note:** For entries greater than 9, press the   buttons through the   buttons for B through F, respectively.
-  For Keypad Access Control, press the  button once again to program applicable keypads. Refer to the tables below, use the number buttons to enter the data for Keypad 1-4 in the right digit; and the data for Keypad 5-7 data in the left digit. (Press the  buttons for blank.)

Example: Enter a code of "123456" as "123456" (from left to right).

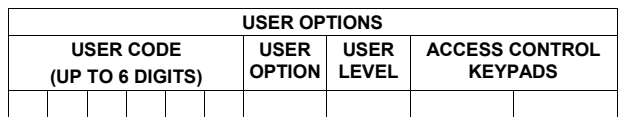

USER OPTIONS				
DATA ENTRIES	BLOCKED VIEW	USER PROGRAM	BYPASS	OVERVIEW
blank (•)	DISABLED			
1	Y			
2		Y		
3	Y	Y		
4			Y	
5	Y		Y	
6		Y	Y	
7	Y	Y	Y	
8				Y
9	Y			Y
0		Y		Y
B	Y	Y		Y
C			Y	Y
D	Y		Y	Y
E		Y	Y	Y
F	Y	Y	Y	Y

Note: "Y" indicates option is enabled.

DATA ENTRIES	AUTHORITY LEVEL	CODE TYPE
blank (•)	NONE	ARM/DISARM
1	LEVEL 1	ARM/DISARM
2	LEVEL 2	ARM/DISARM
3	LEVEL 3	ARM/DISARM
4	NONE	ARM ONLY
5	LEVEL 1	ARM ONLY
6	LEVEL 2	ARM ONLY
7	LEVEL 3	ARM ONLY
8	NONE	SERVICE
9	LEVEL 1	SERVICE
0	LEVEL 2	SERVICE
B	LEVEL 3	SERVICE

ACCESS CONTROL KEYPADS				
DATA ENTRIES	K.P. 5	K.P. 6	K.P. 7	
blank (•)	NONE			
1	Y			
2		Y		
3	Y	Y		
4			Y	
5	Y		Y	
6		Y	Y	
7	Y	Y	Y	
8				
9	Y			
0		Y		
B	Y	Y		
C			Y	
D	Y		Y	
E		Y	Y	
F	Y	Y	Y	

Note: "Y" indicates option is enabled.

ACCESS CONTROL KEYPADS				
DATA ENTRIES	K.P. 1	K.P. 2	K.P. 3	K.P. 4
blank (•)	NONE			
1	Y			
2		Y		
3	Y	Y		
4			Y	
5	Y		Y	
6		Y	Y	
7	Y	Y	Y	
8				Y
9	Y			Y
0		Y		Y
B	Y	Y		Y
C			Y	Y
D	Y		Y	Y
E		Y	Y	Y
F	Y	Y	Y	Y

Note: "Y" indicates option is enabled.

GEM-RP1CAe2 Keypad: User Codes

USER AUTHORITY LEVEL	
KEYPAD DISPLAY FUNCTION MENU	
FUNCTION	LEVEL*
DISPLAY ZN FAULTS	1
DISPLAY ZN BYPASSED	1
DISPLAY ZN DIRECTORY	1
ACTIVATE BELL TEST	1
DISPLAY PHONE #'S	1
DISPLAY SYS TRBL	1
DISPLAY FIRE ALARM	1
DISPLAY FIRE TRBL	1
DISPLAY OP/CL	3
ACTIVATE OVERVIEW	3**
ACTIVATE CHIME	1
ACTIVATE WATCH	2
RESET SYSTEM TRBL	3
RESET SENSOR MSG	3
START EXIT TIME	1
FAULT FIND	***
ACTIVATE LOCATE	***
EZM ZONE FIND	***
ACTIVATE DIALER TEST	3
DISPLAY ALARM LOG	3
DISPLAY TOTAL LOG	3
DISPLAY FIRE LOG	3
DISPLAY OP/CL LOG	3
DISPLAY SYSTEM LOG	3
AUTOARM IN 1-4HRS	2
DISPLAY AUTOARM SCHD	3
ACTIVATE PROGRAM	3**
ACTIVATE DOWNLOAD	3
DISPLY RF XMITTER STAT	1
RELAY CONTROL	1

NOTES:

- * Minimum Level required to access function
- ** Level-3 Code with appropriate user option
- *** Requires Dealer Code



USER OPTIONS	
OPTIONS	EXPLANATION
Disabled	User Code not active in this area.
Blocked View	Allows User Code to block another code from being viewed by another user. An unblocked code cannot view a blocked code, but a blocked code can view all codes. The master user code and the dealer program code can view all codes.
User Program	User Program Option is enabled for Keypad 1 only, wherever it is connected (any area). If enabled, Level 3 must also be enabled.
Bypass	Allows User Code to bypass zones.
Overview	This option, along with Level 3 Authorization, enables selection of OVERVIEW mode at a keypad. This Mode provides a system status display of all areas at a glance.
Arm Only	Prevents User Code from disarming this area.
Service	A Service Code has restricted arm/disarm rights; if an area is armed with a Service Code, a "SERVICE ON" appears on the GEM-RP2ASe2 keypad (a "S" on the GEM-RP1CAe2 keypad) and the area can be disarmed with any valid User Code, including a Service Code. If the area is armed with OTHER than a Service Code, it CANNOT be disarmed with a Service Code. This is typically used to allow tradesmen access to premises under control of the owner.
Access	This is normally used to activate a door striker while an area is disarmed. A code with the access option will not function as an arm/disarm code. When the code is entered, the keypad will display "ENTER NOW" and the Brown Wire on the keypad will become Active Low (Ground Potential) for 7 seconds.

Related User Options: "Ambush Code" (Address 0495), "Panel Access Code" (Address 0490), "Dealer Security Code" (Address 0500) & "Enable User Code by Area" (Address 2500-2547).

Press  to save each code.

To proceed to the next User Code, set the cursor to the User Number and change it using the number buttons. Program a new User Code as previously described. Press NEXT () button to proceed.

Example: Program a code of "2222" for user 02, with User Option of "User Program", User "Level 3" and Access Control Option "Keypad No. 1". Enter "2222" for a user code, "2 3" for user option and "blank(*) 1" for access control option.

CHANGING OR CANCELING A CODE: To change any code, merely program over the existing code as described above and press  to save. Similarly, to cancel a code, blank out each number of the code and press  to save to save.

```

ZN# XMIT# +CS P
ZN01-000000: 0- 0

```

Zone # Mapped to	Xmitter ID	Check Sum	Point #

ID Code number, "A" = ; "B" = ; "C" = ; "D" = ; "E" = ; "F" = . Press to save. Press NEXT () button to proceed.

```

ZN# XMIT# +CS P
ZN01-000000: 0- 0

```

```

ZN# XMIT# +CS P
ZN01-ENROLL:A--

```

RF Transmitter Points (Press the () button to set cursor.)

(For wireless systems only. Also see *Quick Method*, which follows)

For each transmitter (key fob transmitters also), enter the zone number (01–48) to which the transmitter will be mapped, the 6-digit RF ID #:1-digit checksum number printed on the transmitter and box, the point number (1–4); enter "9" for *unsupervised* (all points). **NOTE:** When programming the

Quick Method. If a receiver is already installed in the panel, Napco transmitter wireless points can be programmed automatically ("enrolled") using the following procedure. **NOTE:** The transmitter point will be enrolled only if the signal strength is 3 or greater.

1. Enter the zone number to which the transmitter point will be mapped.
2. Press the () button to enter the Enroll Mode. The red and green LEDs on the keypad will flash and the window will display as shown at left.
3. Open the loop of the point that is to be programmed (GEM-TRANS2 or GEM-TRANS4 only).

4. Install the transmitter battery. The keypad will beep to indicate that the point has been successfully enrolled. Multi-point transmitters can be mapped to successive zones simultaneously (Example 1) or to selected zones point by point (Example 2).

Example 1. A 4-point transmitter has the RF ID number 410078:1. Map the first three points to Zones 11–13, respectively.

1. Enter the Enroll mode as described in step 2 above.
2. Enter Zone "11".
3. Open the loops of points 1, 2 and 3.
4. Install the transmitter battery. The keypad will beep 3 times to indicate that three points have been programmed.
 - Transmitter 410078:1, point 1 will be mapped to Zone 11.
 - Transmitter 410078:1, point 2 will be mapped to Zone 12.
 - Transmitter 410078:1, point 3 will be mapped to Zone 13.

The keypad will now display Zone 13, the last zone enrolled.

Example 2. A 2-point transmitter has the RF ID number 287613:1. Map point 1 to Zone 6 and point 2 to Zone 9.

1. Enter the Enroll mode as described above.
2. Enter Zone "06".
3. Open point-1 loop.
4. Install the battery. The keypad will beep once to indicate that one point has been programmed. (Transmitter 287613:1, point 1 will be mapped to Zone 6.)
5. Enter Zone "09".
6. Close point-1 loop and open point-2 loop.
7. Remove the transmitter battery, then re-install it. The keypad will beep once to indicate that one point has been programmed. (Transmitter 287613:1, point 2 is mapped to Zone 9.)

KEY FOB ZONE ASSIGNMENT: Key fobs can also be assigned to zones to allow multiple wireless panic buttons on one alarm system, each reporting to a central station, a pager or having a description on the keypad that describes the person holding the key fob, the location where the person holding the key fob is stationed, or the special purpose of the key fob button being depressed. See the next page on *Key fob Zone Assignment*.



```

KF R XMIT# + CS OP
01-0 000000:0 00
    
```

Key Fob Transmitters (Press the (FUNCTION) button to set cursor.)

Keyfobs can be programmed as “Arm/Disarm” devices (refer to WI752).

For each Key Fob Transmitter, enter:

the Key Fob Transmitter number (01–08).

area number to which transmitter is assigned (1-2); enter 0 to disable keyfob.

DATA ENTRY	AUX 1/AUX 2 OPTIONS
0	None
1	Relay Group 1 Toggle
2	Relay Group 2 Toggle
9	Panic
A	Auxiliary
B	Instant
C	Aux. Output Toggle
D	Access on Aux. Output

the 6-digit RF ID # printed on the transmitter (enter all numbers and/or letters, including leading “0”s, if any).

1-digit checksum number printed on the transmitter (enter all numbers and/or letters, including leading “0”s, if any).

Aux-1 Option (see key fob aux 1 & aux 2 options).

Aux-2 Option (see key fob aux 1 & aux 2 options).

NOTE: Key fobs 1-8 report openings and closings as Users 25-32.

Note: If the Key Fob is converted for Two Button “Emergency Use” (by cutting an internal jumper), both top or bottom buttons must be depressed to activate an alarm. In this case, Aux-1 and Aux-2 cannot be programmed. Press ON/OFF to save. Press NEXT (INTERIOR) button to proceed.

Key Fob Zone Assignment (refer to display as shown on the previous page: press the (INSTANT) button to go backwards.)

Each of the 4 key fob buttons can be assigned to a zone. For example, On button = point 1; Off button = point 2; A1 = point 3; A2 = point 4. Up to 48 key fobs (using 1 button) or 24 key fobs (using 2 buttons) or 14 key fobs (using all 4 buttons) or any combination up to a maximum of 48 controlled zones can be assigned, providing multiple wireless panic buttons on a system, each reporting to the Central Station or a pager and/or annunciating on a keypad the key fob zone number with description/location. *To assign a key fob to a zone:* program the key fob as you would a transmitter, entering the key fob’s ID code, check sum and point number at the appropriate zone. The “Quick Method” is not allowed. The zone may be hardwired to a sensor as well as assigned to a key fob (either one will activate the zone alarm output). **NOTE:** If assigning a key fob to a zone, the “ON/OFF” buttons on the key fob will no longer arm/disarm the system. The key fob is converted to a “panic only” device.

```

01- _____
_____
    
```

(Direct Entry)

Enter Zone and Interior Descriptions

Press the 1 and 2 buttons to place the cursor; press the 3 and 6 buttons to select the character. For each zone, enter a description of up to two lines. Press ON/OFF to save each description. To proceed

to the next description, place the cursor under the Zone Number (e.g. “01”) and change the Zone Number using the 3 and 6 buttons. Program a new description as above. **NOTE:** Zone Descriptions can only be entered through the GEM-RP1CAe2 Keypad or by using the Napco Quickloader Software. Press NEXT (INTERIOR) button to proceed.

```

ENTER DATE
(01/01/99)
    
```

(Direct Entry)

Enter Date (Press the (FUNCTION) button to set cursor.)

Enter the current date in the format MM/DD/YY, where MM = the month (01–12); DD=the day (01–31); and YY=the year. Press ON/OFF to save. Press NEXT (INTERIOR) button to proceed.

ENTER TIME
(12:05A)

(Direct Entry)





Enter Time (Press the ) button to set cursor.)

Enter the current time in the format HH:MMAM/P, where HH=hours (01–12); MM=minutes (00–59). Select Am or Pm by pressing any number button, then press  once again to save.

DEALER CODE
.....



(Direct Entry)

Dealer Code



Directly enter the Dealer Code, including leading zeros. Use the  through  buttons. **NOTE:** Press the  button for a zero. Press  to save.





DEALER CODE
RE-ENTER

(Direct Entry)

Re-enter the Dealer Code to verify the previous code. Press  to save. Press NEXT () button to proceed.

NOTE: The Dealer Code can be two or more digits (up to 6 digits).

EXIT DEALER PROGRAM MODE: This completes the custom default program. Press the  button to enter the Direct Address Program Mode for further programming or press the  button once again to end all programming and resume normal keypad operation.

CLEAR PROGRAM: Should it be necessary to create a new custom default program, (a) from the Dealer Program Mode, press the  button to enter the Address Program Mode; (b) access Location 4091 (Clear Program) or 4093 (Cold Start); (c) press  and then (d) press the  button to exit the Dealer Program Mode. A “SYSTEM TROUBLE/E09-00 SERVICE” will occur. Press the  button to silence the keypad.

4091 ..

GEM-RP1CAe2 Keypad

Clear Dealer Program (Erases Dealer Program)

This *erases the dealer program*. Use this feature to start a customized default program. Program Data and System Status Memory is erased where Scheduled Data and Zone Descriptions are maintained.

Access address 4091, then press the  button. Data entry is not allowed.

NOTE: Enter Easy Menu Driven Program Mode to program system again.

4093 ..

GEM-RP1CAe2 Keypad

Cold Start (Erases Entire Program)

This erases the entire program including Program Data, Zone Description Data, System Status Data, Schedule Data and Foreign Language configuration(similar to a new panel).

Access address 4093, then press the  button. Data entry is not allowed.

NOTE: Some features (schedules) can only be programmed again with the Downloading Software.

B. GEM-RP2ASe2 Keypad

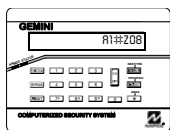

Enter the Master Security Code (printed on microprocessor can) for a new panel or enter your custom Dealer Program Code if programmed. Press **FUNCTION** followed by NO (**INSTANT**) repeatedly until "TURNON/PROG" is displayed. **NOTE:** If you pass "TURNON/PROG", you can scroll back by pressing the **BYPASS** button. Press YES (**INTERIOR**) to enter the Dealer Program Mode. This keypad displays messages in multiple segments. Press the **FUNCTION** button to scroll through each segment.

ENT R1

Total Number of Zones in Area 1 & Area 2 (Appears for New Panel Only)

Directly enter the total number of zones to be programmed for Area 1 and Area 2, respectively. Valid entries are from 01 to 48. Directly enter the total number of zones, including leading zeros. Use number buttons **1** through **9P**. **NOTE:** Press the **0** button for a zero. The system is based on groups of 4 zones each (after the first 8 zones), and will automatically round up to the next group of 4. For example, if you enter 18, it will automatically convert this to 20 zones. Press **ON/OFF** to save. Press NEXT (**INTERIOR**) button to proceed.

#ZNO8

(Direct Entry)

ENT R2

Note: The GEM-P3200 is limited to a combined maximum of 48 zones and 7 keypads. All 48 zones and 7 keypads may be programmed in the EZ Program Mode. For more options, see Zone and Keypad Options in Direct Address Programming.

#ZNO0

(Direct Entry)

ENT FR

Fire Zones (Appears for New Panel Only)

Enter the zone number of any Fire Zones (both 2-wire, 4-wire or wireless). Valid entries are from 01 to 48. Directly enter each zone number, including leading zeros, and press **ON/OFF** to save, and then repeat for any additional zone(s). Press NEXT (**INTERIOR**) button to proceed.

ZN#00

(Direct Entry)

NOTE: If you are programming a 2 Area system, enter the zone number of zones required for Areas 1 & 2. All fire zones are common to areas 1 and 2. The Direct Address Program Mode can then be used to customize them as needed. See Zone Options.

ENT2WF

2-Wire Fire Zones (Appears for New Panel Only)

Enter the zone number of any Fire Zones (from previous question) which are to be used with 2-wire smoke detectors. The only valid entries are 07 and 08. Directly enter each zone number, including leading zeros. Press **ON/OFF** to save, and then repeat for any additional zone. **NOTE:** Only zones which have been designated as Fire Zones can be programmed as 2 Wire Fire zones. Press NEXT (**INTERIOR**) button to proceed. **NOTE:** JP7 must be set to "2-WF" position for 2-wire fire zones 7 and 8 (refer to Installation Instructions).

ZN# 00

(Direct Entry)

REPORT

ALL ZNP

Y/N

(Press YES or NO)

ENT EE

ZN# 00

(Direct Entry)

ENTFOL

ZN# 00

(Direct Entry)



ENT A1





#KP 01





ENT A2





#KP 00





(Direct Entry)

Local System or C.S. Reporting System (Appears for New Panel Only)
 Press YES () button for all zones to report; press NO () button for no zones to report (LOCAL SYSTEM).

Exit/Entry Zones (Appears for New Panel Only)
 Directly enter the zone numbers which are to be used as Exit/Entry zones. Valid entries are from 01 to 48. Directly enter each zone number, including leading zeros. Use number buttons  through . **NOTE:** Press the  button for a zero. Press  to save and then repeat for any additional zone(s). Press NEXT () button to proceed.
NOTE: Exit/Entry Zones will have an entry delay of 30 seconds and an exit delay of 60 seconds. Chime will automatically be programmed for all E/E zones. If you are programming a 2 Area system, enter all of the zones required for Areas 1 & 2.

Interior Zones (Appears for New Panel Only)
 Directly enter the zone numbers which are to be used as Interior Zones. Valid entries are from 01 to 48. Directly enter each zone number, including leading zeros. Use number buttons  through . **NOTE:** Press the  button for a zero. Press  to save and then repeat for any additional zone(s). Press NEXT () button to proceed.
NOTE: All Interior zones will also be automatically programmed as "Exit/Entry Follower" zones. If you are programming a 2 Area system, enter all the zones required for Areas 1 & 2.

Number of Keypads in Area 1
 Directly enter the total number of Keypads to be installed in Area 1. Valid entries are from 01 to 07. Directly enter the number of keypads, including leading zeros. Use number buttons  through . **NOTE:** Press the  button for a zero. Press  to save. Press NEXT () button to proceed.

Number of Keypads in Area 2
 Directly enter the total number of Keypads to be installed in Area 2. Valid entries are from 01 to 07. Directly enter the number of keypads, including leading zeros. Use number buttons  through . **NOTE:** Press the  button for a zero. Press  to save. Press NEXT () button to proceed.

GEM-RP2ASe2 Keypad: CS Reporting, Exit/Entry Zones, Interior Zones & Keypads per Area

PHONE##

(Direct Entry)

ACC##

{ _____ }

(Direct Entry)

REC FMT

{ 0 }

(Direct Entry)

DATA ENTRY	CS RECEIVER 1 FORMAT
blank(*)	Ademco Slow, Silent Knight Slow
1	Sescoa, Vertex, DCI, Franklin Fast
2	Radionics Fast
3	Silent Knight Fast
4	Radionics, DCI, Franklin Slow
5	Universal High Speed
8	Radionics BFSK
9	FBI 4/3/1
0	Radionics Modem 2
B	SIA
C	Ademco Point ID
D	Ademco Express
E	Pager

Central Station Receiver 1 Telephone Number

Press the **FUNCTION** button to scroll screens. Using number buttons, enter telephone number of up to 10 digits including prefix letters, if necessary, for receiver 1. Use number buttons **1** through **9P** for digits 1–9; press the *** 0** button for a zero and *** 1** through *** 5** for letters B–F, respectively. **NOTE:** Pre-Dial Delay = “D”; Dial-Tone Detection = “E”. Pressing the **0** button will produce a blank space (*).

Press **ON/OFF** to save. Press NEXT (**INTERIOR**) button to proceed.

NOTE: The GEM-RP2ASe2 keypad provides a maximum of 10 digits in this mode. To program additional digits, go to the Direct Address Program Mode and continue from Location 0537. Central Station Receiver 2 and 3 Telephone Numbers can only be entered in Direct Address Programming. See CS Receiver Options.

Central Station Receiver 1 Account Number

Press the **FUNCTION** button to scroll screens. Enter an account number of up to four digits. Use number buttons **1** through **9P** for digits 1–9. **NOTE:** Press the *** 0** button for a zero and press **0** button for a blank space (*). Press *** 1** through *** 4** for letters B–E, respectively.

Press **ON/OFF** to save. Press NEXT (**INTERIOR**) button to proceed.

NOTE: Central Station Receiver 2 and 3 Account Numbers can only be entered in Direct Address Programming. See CS Reporting Options.

Central Station Receiver 1 Format

Press the **FUNCTION** button to scroll screens. From the table below, enter the central station's receiver format. Use number buttons **1** through **9P**. **NOTE:** Press the *** 0** button for a zero and press **0** for a blank space (*). Press *** 1** through *** 4** for letters B–E, respectively.

Press **ON/OFF** to save. Press NEXT (**INTERIOR**) button to proceed.





NOTE: Modem IIe format is available only in Direct Address Programming. Central Station Receiver 2 and 3 Formats can only be entered in Direct Address Programming. See CS Receiver Options.





USER01
123 ___
OPT F3
ACC _







(Direct Entry)



Enter User Codes (Press the  button to set cursor.)

Enter up to 48 User Codes with User Options, Authority Level and Access Control Options (if necessary) for each code. Refer to the tables below and on the next page for available data entries for User Options, Authority Level and Access Control Options. **Note:** All 48 Users must be assigned to areas in "Enable User Code by Area" (Address 2500-2547) in Direct Address Programming. By default, only User 1 is enabled in Area 1 and Area 2. User 2 - 8 are enabled in Area 1 and user 9 - 16 are enabled in Area 2

 Press the  button to set the cursor to the User Number. Use the number buttons  through  to enter the User Number.

 Press the  button once to set the cursor to the User Code. Use the number buttons  through  to enter a code of up to 6 digits. Enter up to 6 digits (4 digits is recommended) in the first six boxes from left to right for each user code. Valid entries are: 0-9. **Note:** Press the  button for a zero. No blank spaces in between; leave blank (*) any trailing boxes. If an "Ambush Code" (Address 0495) is entered, *do not* program the first two digits of ANY User Code as the same digits entered for the "Ambush Code".

 If the programmed code was less than 6 digits, press the  button to set the cursor to the OPTION/LEVEL. Refer to the tables shown for the available data entries. Enter the options data in the left digit. Enter the level data (with arming options, if any, added) in the right digit. **Note:** For entries greater than 9, press the   buttons through the   buttons for B through F, respectively.

 For Keypad Access Control, press the  button once again to program applicable keypads. Refer to the tables shown, use the number buttons to enter the data for Keypad 1-4 data in the right digit; and the data for Keypad 5-7 data in the left digit. (Press the  button for blank.)

Example: Enter a code of "123456" as "123456" (from left to right).

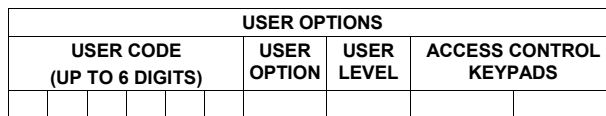

USER OPTIONS				
DATA ENTRIES	BLOCKED VIEW	USER PROGRAM	BYPASS	OVERVIEW
blank (*)	DISABLED			
1	Y			
2		Y		
3	Y	Y		
4			Y	
5	Y		Y	
6		Y	Y	
7	Y	Y	Y	
8				Y
9	Y			Y
0		Y		Y
B	Y	Y		Y
C			Y	Y
D	Y		Y	Y
E		Y	Y	Y
F	Y	Y	Y	Y

Note: "Y" indicates option is enabled.

DATA ENTRIES	AUTHORITY LEVEL	CODE TYPE
blank (*)	NONE	ARM/DISARM
1	LEVEL 1	ARM/DISARM
2	LEVEL 2	ARM/DISARM
3	LEVEL 3	ARM/DISARM
4	NONE	ARM ONLY
5	LEVEL 1	ARM ONLY
6	LEVEL 2	ARM ONLY
7	LEVEL 3	ARM ONLY
8	NONE	SERVICE
9	LEVEL 1	SERVICE
0	LEVEL 2	SERVICE
B	LEVEL 3	SERVICE

ACCESS CONTROL KEYPADS			
DATA ENTRIES	K.P. 5	K.P. 6	K.P. 7
blank (*)	NONE		
1	Y		
2		Y	
3	Y	Y	
4			Y
5	Y		Y
6		Y	Y
7	Y	Y	Y
8			
9	Y		
0		Y	
B	Y	Y	
C			Y
D	Y		Y
E		Y	Y
F	Y	Y	Y

Note: "Y" indicates option is enabled.

ACCESS CONTROL KEYPADS				
DATA ENTRIES	K.P. 1	K.P. 2	K.P. 3	K.P. 4
blank (*)	NONE			
1	Y			
2		Y		
3	Y	Y		
4			Y	
5	Y		Y	
6		Y	Y	
7	Y	Y	Y	
8				Y
9	Y			Y
0		Y		Y
B	Y	Y		Y
C			Y	Y
D	Y		Y	Y
E		Y	Y	Y
F	Y	Y	Y	Y

Note: "Y" indicates option is enabled.

KEYPAD DISPLAY FUNCTION MENU	
FUNCTION	LEVEL*
DISPLAY ZN FAULTS	1
DISPLAY ZN BYPASSED	1
DISPLAY ZN DIRECTORY	1
ACTIVATE BELL TEST	1
DISPLAY PHONE #S	1
DISPLAY SYS TRBL	1
DISPLAY FIRE ALARM	1
DISPLAY FIRE TRBL	1
DISPLAY OP/CL	3
ACTIVATE OVERVIEW	3**
ACTIVATE CHIME	1
ACTIVATE WATCH	2
RESET SYSTEM TRBL	3
RESET SENSOR MSG	3
START EXIT TIME	1
FAULT FIND	***
ACTIVATE LOCATE	***
EZM ZONE FIND	***
ACTIVATE DIALER TEST	3
DISPLAY ALARM LOG	3
DISPLAY TOTAL LOG	3
DISPLAY FIRE LOG	3
DISPLAY OP/CL LOG	3
DISPLAY SYSTEM LOG	3
AUTOARM IN 1-4HRS	2
DISPLAY AUTARM SCHD	3
ACTIVATE PROGRAM	3**
ACTIVATE DOWNLOAD	3
DISPLY RF XMITTER STAT	1
RELAY CONTROL	1

NOTES:

- * Minimum Level required to access function
- ** Level-3 Code with appropriate user option
- *** Requires Dealer Code



USER OPTIONS	
OPTIONS	EXPLANATION
Disabled	User Code not active in this area.
Blocked View	Allows User Code to block another code from being viewed by another user. An unblocked code cannot view a blocked code, but a blocked code can view all codes. The master user code and the dealer program code can view all codes.
User Program	User Program Option is enabled for Keypad 1 only, wherever it is connected (any area). If enabled, Level 3 must also be enabled.
Bypass	Allows User Code to bypass zones.
Overview	This option, along with Level 3 Authorization, enables selection of OVERVIEW mode at a keypad. This Mode provides a system status display of all areas at a glance.
Arm Only	Prevents User Code from disarming this area.
Service	A Service Code has restricted arm/disarm rights; if an area is armed with a Service Code, a "SERVICE ON" appears on the GEM-RP2ASe2 keypad (a "S" on the GEM-RP1CAe2 keypad) and the area can be disarmed with any valid User Code, including a Service Code. If the area is armed with OTHER than a Service Code, it CANNOT be disarmed with a Service Code. This is typically used to allow tradesmen access to premises under control of the owner.
Access	This is normally used to activate a door striker while an area is disarmed. A code with the access option will not function as an arm/disarm code. When the code is entered, the keypad will display "ENTER NOW" and the Brown Wire on the keypad will become Active Low (Ground Potential) for 7 seconds.

Related User Options: "Ambush Code" (Address 0495), "Panel Access Code" (Address 0490), "Dealer Security Code" (Address 0500) & "Enable User Code by Area" (Address 2500-2547).

Press  to save each code.

To proceed to the next User Code, set the cursor to the User Number and change it using the number buttons. Program a new User Code as previously described. Press NEXT () button to proceed.

Example: Program a code of "2222" for user 02, with User Option of "User Program", User "Level 3" and Access Control Option "Keypad No. 1". Enter "2222" for a user code, "2 3" for user option and "blank(*) 1" for access control option.

CHANGING OR CANCELING A CODE: To change any code, merely program over the existing code as described above and press  to save. Similarly, to cancel a code, blank out each number of the code, press  to save.









ZN#01
000000
:0 PTO

(Direct Entry)

ZN#11
ENROLL
:0 PT-

(Direct Entry)



RF Transmitter Points (Press the  button to set cursor.)(For wireless systems only. Also see *Quick Method*, which follows)

For each transmitter (key fob transmitters also), enter the zone number (01–48) to which the transmitter will be mapped, the 6-digit RF ID #:1-digit checksum number printed on the transmitter and box, the point number (1–4); enter “9” for *unsupervised* (all points). **NOTE:** When programming the ID Code number, “A” = ; “B” = ; “C” = ; “D” = ; “E” = ; “F” = . Press  to save. Press NEXT () button to proceed.

Quick Method. If a receiver is already installed in the panel, Napco transmitter wireless points can be programmed automatically (“enrolled”) using the following procedure. **NOTE:** The transmitter point will be enrolled only if the signal strength is 3 or greater.

1. Enter the zone number to which the transmitter point will be mapped.
2. Press the  button to enter the Enroll Mode. The red and green LEDs on the keypad will flash and the window will display as shown at left.
3. Open the loop of the point that is to be programmed (GEM-TRANS2 or GEM-TRANS4 only).
4. Install the transmitter battery. The keypad will beep to indicate that the point has been successfully enrolled. Multi-point transmitters can be mapped to successive zones simultaneously (Example 1) or to selected zones point by point (Example 2).

Example 1. A 4-point transmitter has the RF ID number 410078:1. Map the first three points to Zones 11–13, respectively.

1. Enter the Enroll mode as described in step 2 above.
2. Enter Zone “11”.
3. Open the loops of points 1, 2 and 3.
4. Install the transmitter battery. The keypad will beep 3 times to indicate that three points have been programmed.
 -  Transmitter 410078:1, point 1 will be mapped to Zone 11.
 -  Transmitter 410078:1, point 2 will be mapped to Zone 12.
 -  Transmitter 410078:1, point 3 will be mapped to Zone 13.

The keypad will now display Zone 13, the last zone enrolled.

Example 2. A 2-point transmitter has the RF ID number 287613:1. Map point 1 to Zone 6 and point 2 to Zone 9.

1. Enter the Enroll mode as described above.
2. Enter Zone “06”.
3. Open point-1 loop.
4. Install the battery. The keypad will beep once to indicate that one point has been programmed. (Transmitter 287613:1, point 1 will be mapped to Zone 6.)
5. Enter Zone “09”.
6. Close point-1 loop and open point-2 loop.
7. Remove the transmitter battery, then re-install it. The keypad will beep once to indicate that one point has been programmed. (Transmitter 287613:1, point 2 is mapped to Zone 9.)

KEY FOB ZONE ASSIGNMENT: Key fobs can also be assigned to zones to allow multiple wireless panic buttons on one alarm system, each reporting to a central station, a pager or having a description on the keypad that describes the person holding the key fob, the location where the person holding the key fob is stationed, or the special purpose of the key fob button being depressed. See the next page on *Key fob Zone Assignment*.



KF0801
AREA 0
000000
:000

Key Fob Transmitters (Press the (FUNCTION) button to set cursor.)

Press the (FUNCTION) button to set cursor. Keyfobs can be programmed as “Arm/Disarm” devices (refer to WI752). For each Key Fob Transmitter, enter:

- ☞ the Key Fob Transmitter number (01–08).
- ☞ area number to which transmitter is assigned (1 or 2); enter 0 to disable key fob.
- ☞ the 6-digit RF ID # printed on the transmitter (enter all numbers and/or letters, including leading “0”s, if any).
- ☞ 1-digit checksum number printed on the transmitter (enter all numbers and/or letters, including leading “0”s, if any).
- ☞ Aux-1 Option (see key fob aux 1 & aux 2 options).
- ☞ Aux-2 Option (see key fob aux 1 & aux 2 options).

NOTE: Key fobs 1-8 report openings and closings as Users 25-32.

Note: If the Key Fob is converted for Two Button “Emergency Use” (by cutting an internal jumper), both top or bottom buttons must be depressed to activate an alarms. In this case, the Aux-1 and Aux-2 cannot be programmed.

Press  to save. Press NEXT (INTERIOR) button to proceed.

(Direct Entry)

DATA ENTRY	AUX 1/AUX 2 OPTIONS	DATA ENTRY	AUX 1/AUX 2 OPTIONS
0	None	A	Auxiliary
1	Relay Group 1 Toggle	B	Instant
2	Relay Group 2 Toggle	C	Aux. Output Toggle
9	Panic	D	Access on Aux. Output

Key Fob Zone Assignment (refer to display as shown on the previous page: press the (INSTANT) button to go backwards.)



Each of the 4 key fob buttons can be assigned to a zone. For example, On button = point 1; Off button = point 2; A1 = point 3; A2 = point 4. Up to 48 key fobs (using 1 button) or 24 key fobs (using 2 buttons) or 14 key fobs (using all 4 buttons) or any combination up to a maximum of 48 controlled zones can be assigned, providing multiple wireless panic buttons on a system, each reporting to the Central Station or a pager and/or annunciating on a keypad the key fob zone number with description/location. *To assign a key fob to a zone:* program the key fob as you would a transmitter, entering the key fob's ID code, check sum and point number at the appropriate zone. The “Quick Method” is not allowed. The zone may be hardwired to a sensor as well as assigned to a key fob (either one will activate the zone alarm output). **NOTE:** If assigning a key fob to a zone, the “ON/OFF” buttons on the key fob will no longer arm/disarm the system. The key fob is converted to a “panic only” device.

ZONE DESCRIPTIONS: GEM-RP2ASe2 cannot be used to enter Zone Descriptions. To enter Zone Descriptions you must use the GEM-RP1CAe2 Keypad or the Napco Quickloader Software.

DATE
07/18
/96

(Direct Entry)

Enter Date (Press the  button to set cursor.)

Enter the current date in the format MM/DD/YY, where MM = the month (01–12); DD=the day (01–31); and YY=the year. Press  to save. Press NEXT () button to proceed.

TIME
09:10A

(Direct Entry)





Enter Time (Press the  button to set cursor.)

Enter the current time in the format HH:MMA/P, where HH=hours (01–12); MM=minutes (00–59). Select Am or Pm by pressing any number button, then press  once again to save.

DCODE

(Direct Entry)

Dealer Code

Directly enter the Dealer Code, including leading zeros. Use the  through  buttons. **NOTE:** Press the  button for a zero. Press  to save.

.....

(Direct Entry)



RE-ENT





(Direct Entry)

Re-enter the Dealer Code to verify the previous code. Press  to save.

Press NEXT () button to proceed.

NOTE: The Dealer Code can be two or more digits (up to 6 digits).

EXIT DEALER PROGRAM MODE: This completes the custom default program. Press the  button to enter the Direct Address Program Mode for further programming or press the  button once again to end all programming and resume normal keypad operation.

CLEAR PROGRAM: Should it be necessary to create a new custom default program, (a) from the Dealer Program Mode, press the  button to enter the Address Program Mode; (b) access Location 4091 (Clear Program) or 4093 (Cold Start); (c) press  and then (d) press the  button to exit the Dealer Program Mode. A System Trouble Condition will occur. Press the  button to silence the keypad.

B. GEM-RP3DGTL Keypad

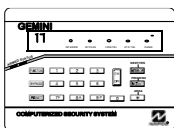

Enter the Master Security Code (printed on microprocessor can) for a new panel or enter your custom Dealer Program Code if programmed. Press **FUNCTION**, followed by NO (**INSTANT**) repeatedly until "17" is displayed. **NOTE:** If you pass Function "17", you can scroll back by pressing the **BYPASS** button. Press YES (**INTERIOR**) to enter the Dealer Program Mode. The GEM-RP3DGTL is a dual 7-segment digital keypad. The questions will be in the form of a 2 digit number flashing in the digital display. Press the **FUNCTION** button to scroll through each segment.

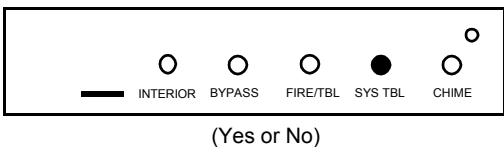
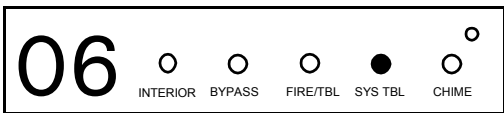
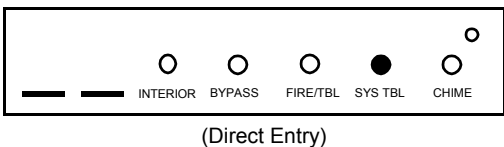
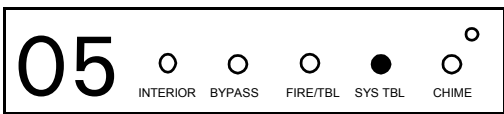
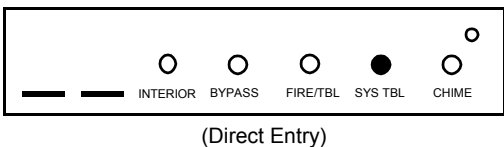
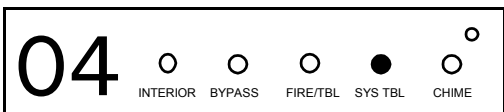
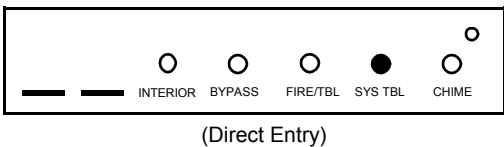
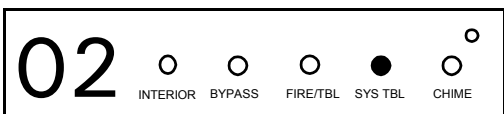
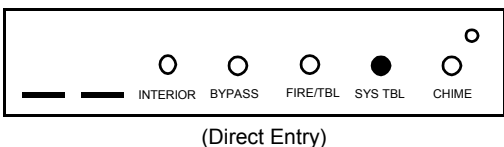
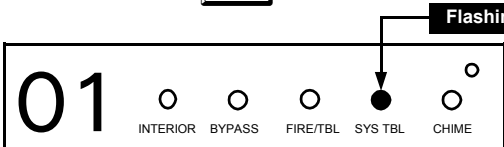

Total Number of Zones in Area 1 & Area 2 (Appears for New Panel Only)

Directly enter the total number of zones to be programmed for Area 1 and Area 2, respectively. Valid entries are from 01 to 48. Directly enter the total number of zones, including leading zeros. Use number buttons **1** through **9 P**. **NOTE:** Press the **0** button for a zero. The system is based on groups of 4 zones each (after the first 8 zones), and will automatically round up to the next group of 4. For example, if you enter 18, it will automatically convert this to 20 zones. Press **ON/OFF** to save. Press NEXT (**INTERIOR**) button to proceed.

Note: The GEM-P3200 is limited to a combined maximum of 48 zones and 7 keypads. All 48 zones and 7 keypads may be programmed in the EZ Program Mode. For more options, see Zone and Keypad Options in Direct Address Programming.

Fire Zones (Appears for New Panel Only)

Enter the zone number of any Fire Zones (both 2-wire, 4-wire or wireless). Valid entries are from 01 to 48. Directly enter each zone number, including leading zeros, and press **ON/OFF** to save, and then repeat for any additional zone(s). Press NEXT (**INTERIOR**) button to proceed.

NOTE: If you are programming a 2 Area system, enter the zone number of zones required for Areas 1 & 2. All fire zones are common to areas 1 and 2. The Direct Address Program Mode can then be used to customize them as needed. See Zone Options.

2-Wire Fire Zones (Appears for New Panel Only)

Enter the zone number of any Fire Zones (from previous question) which are to be used with 2-wire smoke detectors. The only valid entries are 07 and 08. Directly enter each zone number, including leading zeros. Press **ON/OFF** to save, and then repeat for any additional zone. **NOTE:** Only zones which have been designated as Fire Zones can be programmed as 2 Wire Fire zones. Press NEXT (**INTERIOR**) button to proceed. **NOTE:** JP7 must be set to "2-WF" position for 2-wire fire zones 7 and 8 (refer to Installation Instructions).



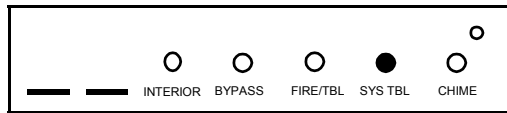
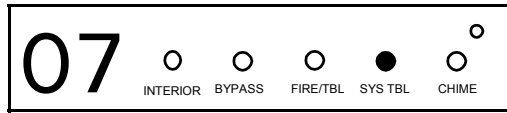

Local System or C.S. Reporting System (Appears for New Panel Only)

Press YES (**INTERIOR**) button for all zones to report; press NO (**INSTANT**) button for no zones to report (LOCAL SYSTEM).



(Direct Entry)

Exit/Entry Zones *(Appears for New Panel Only)*



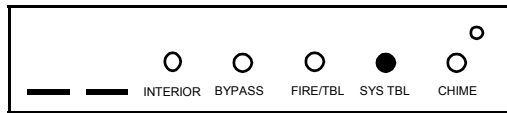
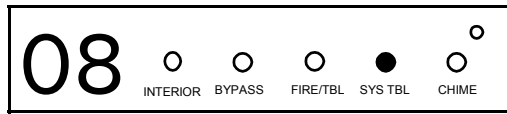

Directly enter the zone numbers which are to be used as Exit/Entry zones. Valid entries are from 01 to 48. Directly enter each zone number, including leading zeros. Use number buttons  through . **NOTE:** Press the  button for a zero. Press  to save and then repeat for any additional zone(s). Press NEXT () button to proceed.

NOTE: Exit/Entry Zones will have an entry delay of 30 seconds and an exit delay of 60 seconds. Chime will automatically be programmed for all E/E zones. If you are programming a 2 Area system, enter all of the zones required for Areas 1 & 2.



(Direct Entry)

Interior Zones *(Appears for New Panel Only)*



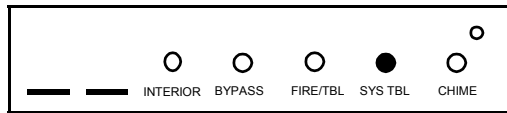
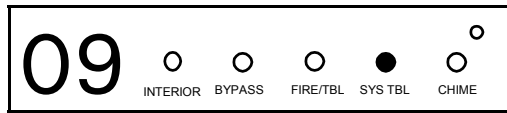

Directly enter the zone numbers which are to be used as Interior Zones. Valid entries are from 01 to 48. Directly enter each zone number, including leading zeros. Use number buttons  through . **NOTE:** Press the  button for a zero. Press  to save and then repeat for any additional zone(s). Press NEXT () button to proceed.

NOTE: All Interior zones will also be automatically programmed as "Exit/Entry Follower" zones. If you are programming a 2 Area system, enter all the zones required for Areas 1 & 2.



(Direct Entry)



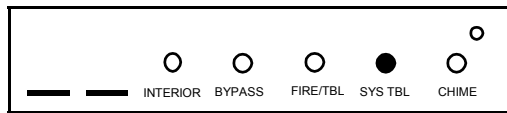
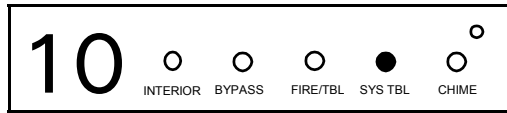

Number of Keypads in Area 1

Directly enter the total number of Keypads to be installed in Area 1. Valid entries are from 01 to 07. Directly enter the number of keypads, including leading zeros. Use number buttons  through . **NOTE:** Press the  button for a zero. Press  to save. Press NEXT () button to proceed.



(Direct Entry)





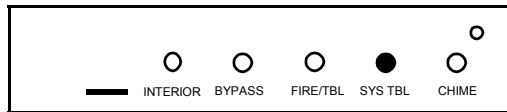
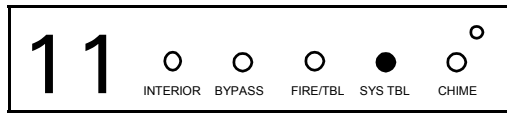





Number of Keypads in Area 2

Directly enter the total number of Keypads to be installed in Area 2. Valid entries are from 01 to 07. Directly enter the number of keypads, including leading zeros. Use number buttons  through . **NOTE:** Press the  button for a zero. Press  to save. Press NEXT () button to proceed.



(Direct Entry)

Central Station Receiver 1 Telephone Number

Using number buttons, enter telephone number of up to 16 digits including prefix letters, if necessary, for receiver 1. Use number buttons  through  for digits 1-9; press the   button for a zero and   through   for letters B-F, respectively. **NOTE:** Pre-Dial Delay = "D"; Dial-Tone Detection = "E". Pressing the  button will produce a blank space (•). Press  to save. Press NEXT () to proceed.

NOTE: Central Station Receiver 2 and 3 Telephone Numbers can only be entered in Direct Address Programming. See CS Receiver Options.

GEM-RP3DGTL Keypad: Exit/Entry Zones, Interior Zones, Keypads per Area & CS Tel. No.

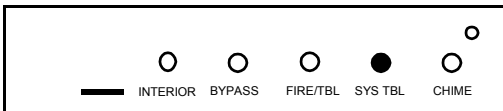
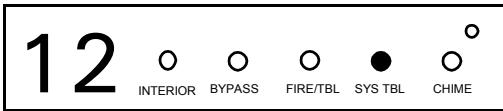

(Direct Entry)

Central Station Receiver 1 Account Number

Enter an account number of up to four digits. Use number buttons through for digits 1–9. **NOTE:** Press the button for a zero and press the buttons for a blank space (•). Press to save .

Press NEXT () button to proceed. **NOTE:** Central Station Receiver 2 and 3 Account Numbers can only be entered in Direct Address Programming. See CS Reporting Options.

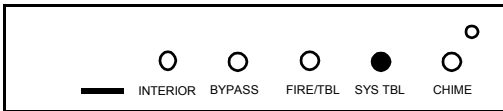
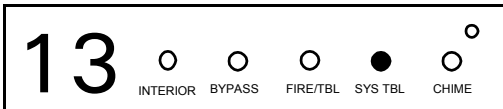

(Direct Entry)

Central Station Receiver 1 Format

From the table below, enter the central station's receiver format. Use number buttons through . **NOTE:** Press the button for a zero. and press the buttons for a blank space (•). Press through for letters B–E, respectively.

Press to save. Press NEXT () button to proceed.

DATA ENTRY	CS RECEIVER 1 FORMAT
blank(•)	Ademco Slow, Silent Knight Slow
1	Sescoa, Vertex, DCI, Franklin Fast
2	Radionics Fast
3	Silent Knight Fast
4	Radionics, DCI, Franklin Slow
5	Universal High Speed
8	Radionics BFSK

DATA ENTRY	CS RECEIVER 1 FORMAT
9	FBI 4/3/1
0	Radionics Modem 2
B	SIA
C	Ademco Point ID
D	Ademco Express
E	Pager



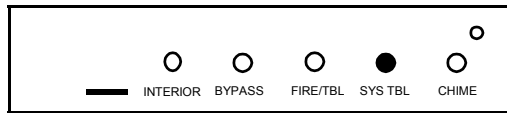
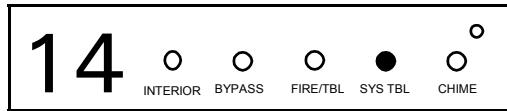











NOTE: Modem IIe is available only in Direct Address Programming. Central Station Receiver 2 and 3 Formats can only be entered in Direct Address Programming. See CS Receiver Options.



(Direct Entry)

Enter User Codes (Press the  button to set cursor.)

Enter up to 48 User Codes with User Options, Authority Level and Access Control Options (if necessary) for each code. Refer to the tables below and on the next page for available data entries for User Options, Authority Level and Access Control Options. **Note:** All 48 Users must be assigned to areas in "Enable User Code by Area" (Address 2500-2547) in Direct Address Programming. By default, only User 1 is enabled in Area 1 and Area 2. User 2 - 8 are enabled in Area 1 and user 9 - 16 are enabled in Area 2

-  Press the  button once to set the cursor to the User Code. Use the number buttons  through  to enter a code of up to 6 digits. Enter up to 6 digits (4 digits are recommended) in the first six boxes from left to right for each user code. Valid entries are: 0-9. **Note:** Press the  button for a zero. No blank spaces in between; leave blank (*) any trailing boxes. If an "Ambush Code" (Address 0495) is entered, *do not* program the first two digits of ANY User Code as the same digits entered for the "Ambush Code".
-  If the programmed code is less than 6 digits, press the  button to set the cursor to the OPTION/LEVEL. Refer to the tables below for the available User Option and User Level data entries. Enter the user options data in the left digit. Enter the level data (with arming options, if any, added) in the right digit. **Note:** For entries greater than 9, press the   buttons through the   buttons for B through F, respectively.
-  For Keypad Access Control, press the  button once again to program applicable keypads. Refer to the tables below, use the number buttons to enter the data for Keypad 1-4 in the right digit; and the data for Keypad 5-7 data in the left digit. (Press the  buttons for blank.)

Example: Enter a code of "123456" as "123456" (from left to right).

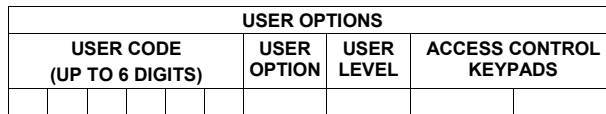

USER OPTIONS				
DATA ENTRIES	BLOCKED VIEW	USER PROGRAM	BYPASS	OVERVIEW
blank (*)	DISABLED			
1	Y			
2		Y		
3	Y	Y		
4			Y	
5	Y		Y	
6		Y	Y	
7	Y	Y	Y	
8				Y
9	Y			Y
0		Y		Y
B	Y	Y		Y
C			Y	Y
D	Y		Y	Y
E		Y	Y	Y
F	Y	Y	Y	Y

Note: "Y" indicates option is enabled.

DATA ENTRIES	AUTHORITY LEVEL	CODE TYPE
blank (*)	NONE	ARM/DISARM
1	LEVEL 1	ARM/DISARM
2	LEVEL 2	ARM/DISARM
3	LEVEL 3	ARM/DISARM
4	NONE	ARM ONLY
5	LEVEL 1	ARM ONLY
6	LEVEL 2	ARM ONLY
7	LEVEL 3	ARM ONLY
8	NONE	SERVICE
9	LEVEL 1	SERVICE
0	LEVEL 2	SERVICE
B	LEVEL 3	SERVICE

ACCESS CONTROL KEYPADS			
DATA ENTRIES	K.P. 5	K.P. 6	K.P. 7
blank (*)	NONE		
1	Y		
2		Y	
3	Y	Y	
4			Y
5	Y		Y
6		Y	Y
7	Y	Y	Y
8			
9	Y		
0		Y	
B	Y	Y	
C			Y
D	Y		Y
E		Y	Y
F	Y	Y	Y

Note: "Y" indicates option is enabled.

ACCESS CONTROL KEYPADS				
DATA ENTRIES	K.P. 1	K.P. 2	K.P. 3	K.P. 4
blank (*)	NONE			
1	Y			
2		Y		
3	Y	Y		
4			Y	
5	Y		Y	
6		Y	Y	
7	Y	Y	Y	
8				Y
9	Y			Y
0		Y		Y
B	Y	Y		Y
C			Y	Y
D	Y		Y	Y
E		Y	Y	Y
F	Y	Y	Y	Y

Note: "Y" indicates option is enabled.

USER AUTHORITY LEVEL	
KEYPAD DISPLAY FUNCTION MENU	
FUNCTION	LEVEL*
DISPLAY ZN FAULTS	1
DISPLAY ZN BYPASSED	1
DISPLAY ZN DIRECTORY	1
ACTIVATE BELL TEST	1
DISPLAY PHONE #'S	1
DISPLAY SYS TRBL	1
DISPLAY FIRE ALARM	1
DISPLAY FIRE TRBL	1
DISPLAY OP/CL	3
ACTIVATE OVERVIEW	3**
ACTIVATE CHIME	1
ACTIVATE WATCH	2
RESET SYSTEM TRBL	3
RESET SENSOR MSG	3
START EXIT TIME	1
FAULT FIND	***
ACTIVATE LOCATE	***
EZM ZONE FIND	***
ACTIVATE DIALER TEST	3
DISPLAY ALARM LOG	3
DISPLAY TOTAL LOG	3
DISPLAY FIRE LOG	3
DISPLAY OP/CL LOG	3
DISPLAY SYSTEM LOG	3
AUTOARM IN 1-4HRS	2
DISPLAY AUTARM SCHD	3
ACTIVATE PROGRAM	3**
ACTIVATE DOWNLOAD	3
DISPLY RF XMITTER STAT	1
RELAY CONTROL	1

NOTES:

- * Minimum Level required to access function
- ** Level-3 Code with appropriate user option
- *** Requires Dealer Code



USER OPTIONS	
OPTIONS	EXPLANATION
Disabled	User Code not active in this area.
Blocked View	Allows User Code to block another code from being viewed by another user. An unblocked code cannot view a blocked code, but a blocked code can view all codes. The master user code and the dealer program code can view all codes.
User Program	User Program Option is enabled for Keypad 1 only, wherever it is connected (any area). If enabled, Level 3 must also be enabled.
Bypass	Allows User Code to bypass zones.
Overview	This option, along with Level 3 Authorization, enables selection of OVERVIEW mode at a keypad. This Mode provides a system status display of all areas at a glance.
Arm Only	Prevents User Code from disarming this area.
Service	A Service Code has restricted arm/disarm rights; if an area is armed with a Service Code, a "SERVICE ON" appears on the GEM-RP2ASe2 keypad (a "5" on the GEM-RP1CAe2 keypad) and the area can be disarmed with any valid User Code, including a Service Code. If the area is armed with OTHER than a Service Code, it CANNOT be disarmed with a Service Code. This is typically used to allow tradesmen access to premises under control of the owner.
Access	This is normally used to activate a door striker while an area is disarmed. A code with the access option will not function as an arm/disarm code. When the code is entered, the keypad will display "ENTER NOW" and the Brown Wire on the keypad will become Active Low (Ground Potential) for 7 seconds.

Related User Options: Ambush Code" (Address 0495), "Panel Access Code" (Address 0490), "Dealer Security Code" (Address 0500) & "Enable User Code by Area" (Address 2500-2547).

Press  to save each code.

To proceed to the next User Code, set the cursor to the User Number and change it using the number buttons. Program a new User Code as previously described. Press NEXT () button to proceed.





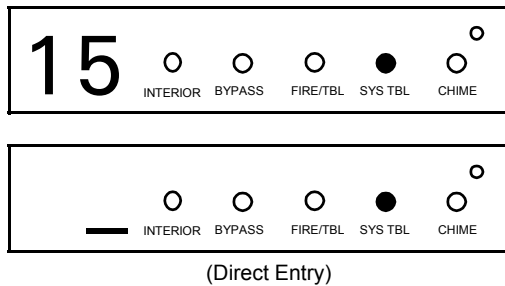



Example: Program a code of "2222" for user 02, with User Option of "User Program", User "Level 3" and Access Control Option "Keypad No. 1". Enter "2222" for a user code, "2 3" for user option and "blank(*) 1" for access control option.

CHANGING OR CANCELING A CODE: To change any code, merely program over the existing code as described above and press  to save. Similarly, to cancel a code, blank out each number of the code press  to save to save.



RF Transmitter Points (Press the button to set cursor.)



(For wireless systems only. Also see *Quick Method*, which follows)

For each transmitter (key fob transmitters also), enter the zone number (01–48) to which the transmitter will be mapped, the 6-digit RF ID #:1-digit checksum number printed on the transmitter and box, the point number (1–4); enter “9” for *unsupervised* (all points). **NOTE:** When programming the ID Code number, “A” = ; “B” = ; “C” = ; “D” = ; “E” = ; “F” = . Press  to save. Press NEXT () button to proceed.

Quick Method. If a receiver is already installed in the panel, Napco transmitter wireless points can be programmed automatically (“enrolled”) using the following procedure. **NOTE:** The transmitter point will be enrolled only if the signal strength is 3 or greater.

1. Enter the zone number to which the transmitter point will be mapped.
2. Press the  button to enter the Enroll Mode. The red and green LEDs on the keypad will flash and the window will display as shown at left.
3. Open the loop of the point that is to be programmed (GEM-TRANS2 or GEM-TRANS4 only).
4. Install the transmitter battery. The keypad will beep to indicate that the point has been successfully enrolled. Multi-point transmitters can be mapped to successive zones simultaneously (Example 1) or to selected zones point by point (Example 2).

Example 1. A 4-point transmitter has the RF ID number 410078:1. Map the first three points to Zones 11–13, respectively.

1. Enter the Enroll mode as described in step 2 above.
2. Enter Zone “11”.
3. Open the loops of points 1, 2 and 3.
4. Install the transmitter battery. The keypad will beep 3 times to indicate that three points have been programmed.
 -  Transmitter 410078:1, point 1 will be mapped to Zone 11.
 -  Transmitter 410078:1, point 2 will be mapped to Zone 12.
 -  Transmitter 410078:1, point 3 will be mapped to Zone 13.

The keypad will now display Zone 13, the last zone enrolled.

Example 2. A 2-point transmitter has the RF ID number 287613:1. Map point 1 to Zone 6 and point 2 to Zone 9.

1. Enter the Enroll mode as described above.
2. Enter Zone “06”.
3. Open point-1 loop.
4. Install the battery. The keypad will beep once to indicate that one point has been programmed. (Transmitter 287613:1, point 1 will be mapped to Zone 6.)
5. Enter Zone “09”.
6. Close point-1 loop and open point-2 loop.
7. Remove the transmitter battery, then re-install it. The keypad will beep once to indicate that one point has been programmed. (Transmitter 287613:1, point 2 is mapped to Zone 9.)

KEY FOB ZONE ASSIGNMENT: Key fobs can also be assigned to zones to allow multiple wireless panic buttons on one alarm system, each reporting to a central station, a pager or having a description on the keypad that describes the person holding the key fob, the location where the person holding the key fob is stationed, or the special purpose of the key fob button being depressed. *See the next page on Key fob Zone Assignment.*

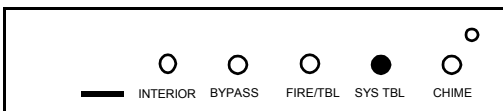
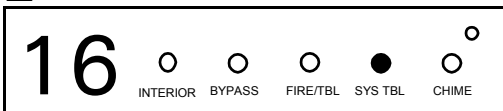

(Direct Entry)

DATA ENTRY	AUX 1/AUX 2 OPTIONS
0	None
1	Relay Group 1 Toggle
2	Relay Group 2 Toggle
9	Panic
A	Auxiliary
B	Instant
C	Aux. Output Toggle
D	Access on Aux. Output

Key Fob Transmitters (Press the **FUNCTION** button to set cursor.)

Keyfobs can be programmed as “Arm/Disarm” devices. (refer to WI752).

For each Key Fob Transmitter, enter:

- ☞ the Key Fob Transmitter number (01–08).
- ☞ area number to which transmitter is assigned (1 or 2); enter 0 to disable keyfob.
- ☞ the 6-digit RF ID # printed on the transmitter (enter all numbers and/or letters, including leading “0”s, if any).
- ☞ 1-digit checksum number printed on the transmitter (enter all numbers and/or letters, including leading “0”s, if any).

☞ Aux-1 Option (see key fob aux 1 & aux 2 options).

☞ Aux-2 Option (see key fob aux 1 & aux 2 options).

NOTE: Key fobs 1-8 report openings and closings as Users 25-32.

Note: If the Key Fob is converted for Two Button “Emergency Use” (by cutting an internal jumper), both top or bottom buttons must be depressed to activate an alarm. In this case, the Aux-1 and Aux-2 cannot be programmed. Press **ON/OFF** to save. Press NEXT (**INTERIOR**) button to proceed.

Key Fob Zone Assignment (refer to display as shown on the previous page: press the **INSTANT** button to go backwards.)

Each of the 4 key fob buttons can be assigned to a zone. For example, On button = point 1; Off button = point 2; A1 = point 3; A2 = point 4. Up to 48 key fobs (using 1 button) or 24 key fobs (using 2 buttons) or 14 key fobs (using all 4 buttons) or any combination up to a maximum of 48 controlled zones can be assigned, providing multiple wireless panic buttons on a system, each reporting to the Central Station or a pager and/or annunciating on a keypad the key fob zone number with description/location. *To assign a key fob to a zone:* program the key fob as you would a transmitter, entering the key fob's ID code, check sum and point number at the appropriate zone. The “Quick Method” is not allowed. The zone may be hardwired to a sensor as well as assigned to a key fob (either one will activate the zone alarm output). **NOTE:** If assigning a key fob to a zone, the “ON/OFF” buttons on the key fob will no longer arm/disarm the system. The key fob is converted to a “panic only” device.

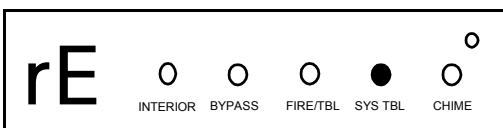
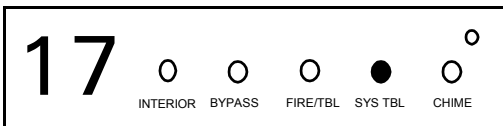

(Direct Entry)

Dealer Code

Directly enter the Dealer Code, including leading zeros. Use the **1** through **9P** buttons. **NOTE:** Press the **0** button for a zero. Press **ON/OFF** to save.

Re-enter the Dealer Code to verify the previous code. Press **ON/OFF** to save. Press NEXT (**INTERIOR**) button to proceed.

NOTE: The Dealer Code can be two or more digits (up to 6 digits).

EXIT DEALER PROGRAM MODE: This completes the custom default program. Press the **RESET** button to enter the Direct Address Program Mode for further programming or press the **RESET** button once again to end all programming and resume normal keypad operation.

CLEAR PROGRAM: Should it be necessary to create a new custom default program, (a) from the Dealer Program Mode, press the **RESET** button to enter the Address Program Mode; (b) access Location 4091 (Clear Program) or 4093 (Cold Start); (c) press **ON/OFF** and then (d) press the **RESET** button to exit the Dealer Program Mode. A System Trouble Condition will occur. Press the **RESET** button to silence the keypad.

DIRECT ADDRESS PROGRAM MODE

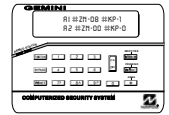

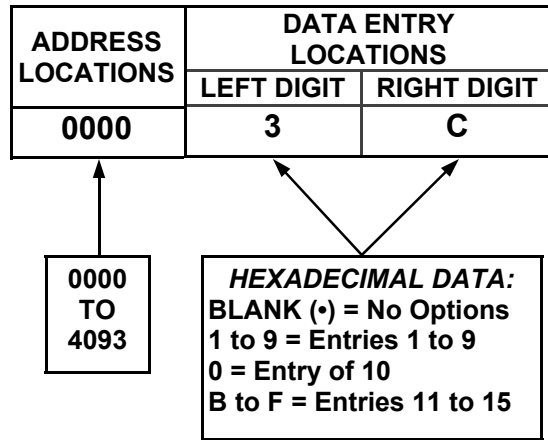

This is an extension of the Dealer Program Mode. This method of programming is used in conjunction with the Keypad Programming Worksheets that follow. Refer to these worksheets to identify the 4-digit location (address) of the feature to be programmed. An illustrative example is provided on the next page.



KEYPAD PROGRAMMING OVERVIEW

Direct Address Programming allows you to go directly to the address locations and change the data entries to customize your control panel options. Whereas the Easy Menu Program Mode is a simple quick start guide with limited options, the Direct Address Program Mode is more flexible allowing you to change all the options. It consists of multiple address locations (up to 4093) with two data entry locations each (left and right) as shown in the adjacent diagram.

ACCESSING DIRECT ADDRESS PROGRAM MODE

1. Press  

Master Security Code
 (printed on microprocessor can)
 or
 Dealer Security Code (Address 0500)

2. Press  Until "ACTIVATE PROGRAM Y/N" (GEM-RP1CAe2), "TURNON PROG Y/N" (GEM-RP2ASe2) or "11" (GEM-RP3DGTL) appears on the keypad display.

3. Press  To Enter Dealer Program Mode

4. Press  To Exit Easy Menu Driven Program Mode & Enter Direct Address Program Mode

KEYPAD ADDRESS PROGRAM MODE DISPLAY

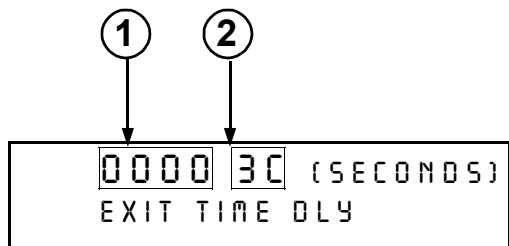

GEM-RP1CAe2 Keypad

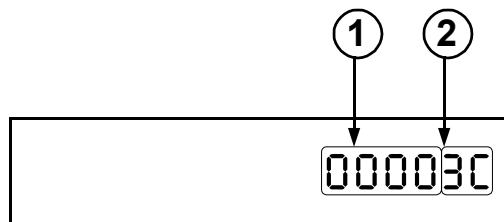

GEM-RP2ASe2 Keypad

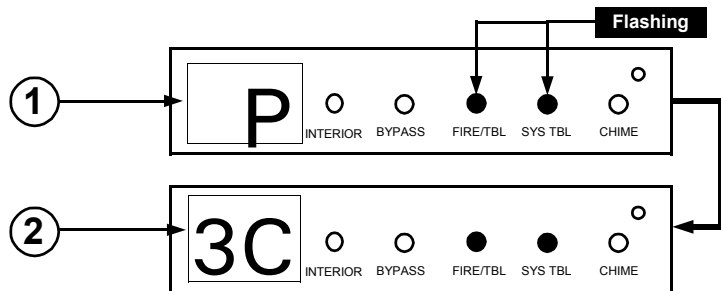

(Direct Entry)

GEM-RP3DGTL Keypad

Press the **FUNCTION** followed by 4 digit address location. **NOTE:** The address location will flash rapidly and then disappear with the corresponding data

① = ADDRESS LOCATION ② = DATA ENTRY LOCATION (Left and Right Digits)

DIRECT ADDRESS PROGRAM MODE KEYPAD COMMANDS

A. GEM-RP1CAe2 Keypads

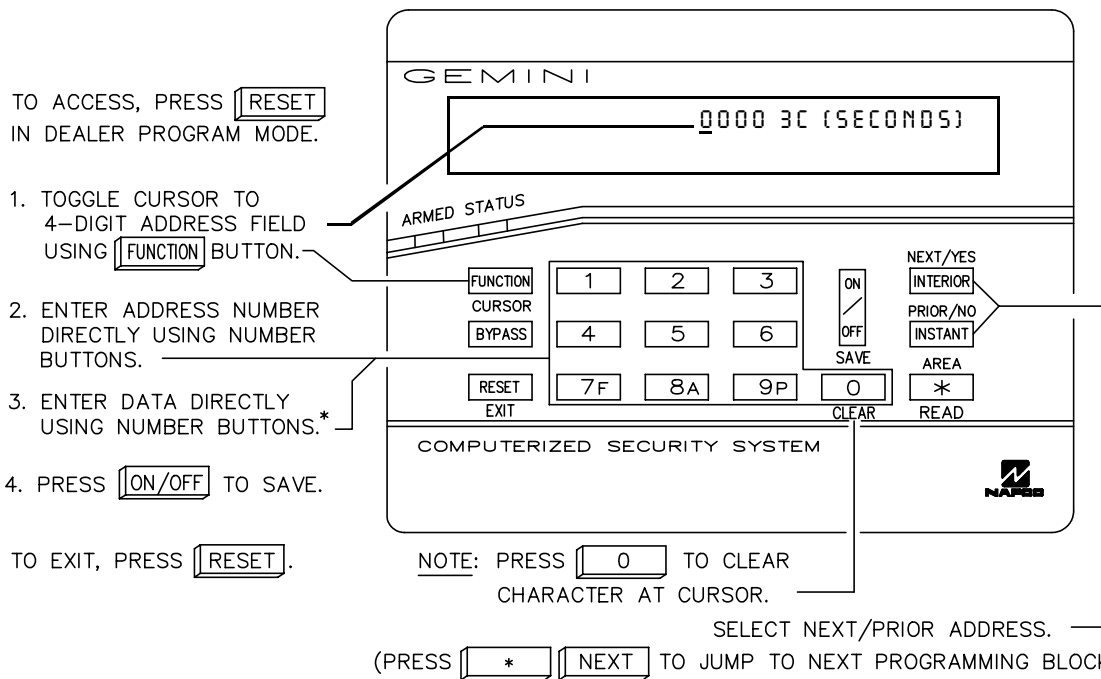

B. GEM-RP2ASe2 Keypad

TO ACCESS, PRESS **RESET** IN DEALER PROGRAM MODE.

1. TOGGLE CURSOR TO 4-DIGIT ADDRESS FIELD USING **FUNCTION** BUTTON.
2. ENTER ADDRESS NUMBER DIRECTLY USING NUMBER BUTTONS.
3. ENTER DATA DIRECTLY USING NUMBER BUTTONS.*
4. PRESS **ON/OFF** TO SAVE.

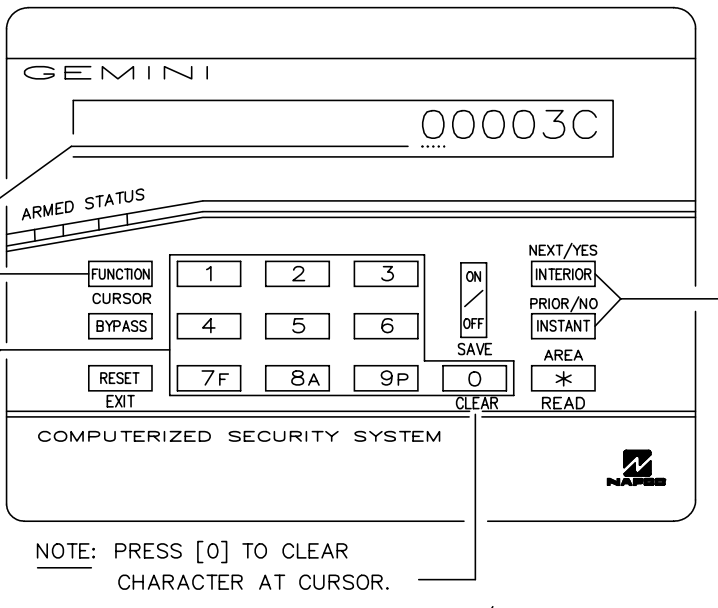

NOTE: PRESS [0] TO CLEAR CHARACTER AT CURSOR.

TO EXIT, PRESS **RESET**.

SELECT NEXT/PRIOR ADDRESS. (PRESS ***** **NEXT** TO JUMP TO NEXT PROGRAMMING BLOCK.)

PRESS "[][0]"-"[*][5]" FOR 10-15 (A-F), RESPECTIVELY.

C. GEM-RP3DGTL Keypad

To access, press the **RESET** button in the Easy Menu Mode.

1. Press the **FUNCTION** button.
2. Enter the 4 digit Address location directly using number buttons (0-9).
3. Enter the 2 digit data directly using number buttons (0-9).
4. Press the **ON/OFF** button to save.

To exit, press the **RESET** button

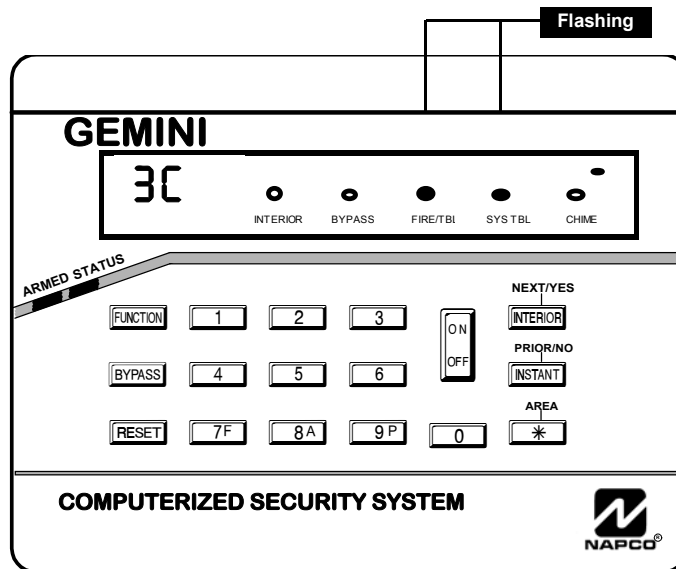

NOTE: "A" = ***** **0**; "B" = ***** **1**; "C" = ***** **2**; "D" = ***** **3**; "E" = ***** **4**; "F" = ***** **5**. Press **0** for a zero or to clear.

The displays shown on the previous page will appear after a brief delay.

- ☞ Use the the **FUNCTION** button to toggle the cursor between the 4-digit address field and the data entry locations.
- ☞ Enter the address directly using the number buttons.
- ☞ The contents of the address will be read automatically, along with the feature name and programming information. The cursor will advance to the data field. Enter the required data directly using the number buttons.
- ☞ Press **ON/OFF** to save the contents of each address.

EXIT DIRECT ADDRESS PROGRAM MODE: When done, press the **RESET** button to exit and resume normal keypad operation.

PROGRAMMING OVERVIEW

The Keypad Programming Worksheets in the back are provided as an address-programming reference to help the installer modify his custom default program or to make minor field alterations to an existing panel program. It is recommended that the panel be uploaded to NAPCO's Quickloader software following any keypad programming and that the PCD3000's error-check feature be utilized to reduce the possibility of programming omissions or conflicts.

Note: Most of the addresses shown comprise two data entry locations, left and right digits. Program the left digits on the left data-display segment, and the right digit on the right segment. For those addresses having only one programmable nibble, program the right segment only; the left segment should display a blank (*).

Keep the Keypad Programming Worksheets on file for future reference.

General Programming Steps

- ☞ 1. Contact the central station to ascertain receiver format, data format, event codes, subscriber numbers and telephone number(s).
- ☞ 2. Select the desired features by circling the respective "address" boxes. Refer to the Programming Options and Worksheets for guidance in selecting the "data" (1,2,4,8) to be entered into those boxes.
- ☞ 3. Program the data entered in the boxes on the worksheets into the respective addresses. The display will show the entry numerically, but will display "0" for the number 10, and letters "B", "C", "D", "E", and "F" for the numbers 11 through 15, respectively. To program a 10, press *** 0**. To program 11 through 15, press *** 1** through *** 5**, respectively.

NOTE: See the Direct Address Programming Example on the following page.

DATA ENTRY SELECTIONS (BINARY VALUE CIRCLED)				ENTRY TOTAL	PRESS	KEYPAD DISPLAYS
8	4	2	1	blank	0	•
8	4	2	①	1	1	1
8	4	②	1	2	2	2
8	4	②	①	3	3	3
8	④	2	1	4	4	4
8	④	2	①	5	5	5
8	④	②	1	6	6	6
8	④	②	①	7	7F	7
⑧	4	2	1	8	8A	8
⑧	4	2	①	9	9P	9
⑧	4	②	1	10	* 0	0
⑧	4	②	①	11	* 1	B
⑧	④	2	1	12	* 2	C
⑧	④	2	①	13	* 3	D
⑧	④	②	1	14	* 4	E
⑧	④	②	①	15	* 5	F



Table 1. Determining data entry for a location (each "nibble"). Numbers in parentheses indicate data for selected zones or features. (See Programming Worksheets that follow.)

Direct Address Programming Example

Example: Program Zones 6, 7 and 8 as Exit/Entry Follower Zones.

DETERMINE THE DATA ENTRIES

1. Referring to ZONE FEATURES in the Programming Worksheets that follow, Exit/Entry Follower for Zones 5 through 8 are located at address 1218, left digit. Circle the data values for Zones 5–8.
2. Add the data values for Zones 6, 7 and 8: $2+4+8=14$. From Tables 1 and 2, "14" (E) is entered as press . The right digit (for Zones 1 through 4, none of which are Exit/Entry Follower Zones) is entered as a blank (•).

ZONE OPTION	ZONES LEFT DATA VALUES				ADDRESS			ZONES RIGHT DATA VALUES			
	SUM = 14 (CIRCLE )				1218			SUM = 0 (CIRCLE )			
	ZN08	ZN07	ZN06	ZN05	L	ADDR	R	ZN04	ZN03	ZN02	ZN01
EXIT/ENTRY FOLLOWER	⑧	④	②	1	E	1218	blank (•)	8	4	2	1

 ENTER DATA

PROGRAM THE DATA ENTRIES

1. Enter the panel's Dealer Security Code (Address 0500), then press the button.
2. Answer NO () to all questions until "ACTIVATE PROGRAM Y/N" is displayed; then press YES ().
NOTE: If you pass "ACTIVATE PROGRAM", scroll backward using the button.
3. Press the button to enter the Address Program Mode. Address "0000" will display.
4. Press to access Address 1218. The data for both digits will display and the cursor will advance to the data field.
5. Press to enter an "E" in the left digit and press to enter a blank (•) in the right digit.
6. Press to save.

PROGRAMMING OPTIONS & WORKSHEETS

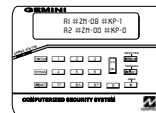

1. Press **FUNCTION**

Dealer Code (Address 0500)

2. Press **INSTANT** Until "ACTIVATE PROGRAM Y/N" (**GEM-RP1CAe2**) or "TURNON PROG Y/N" (**GEM-RP2ASe2**) appears on LCD screen or Function "17" (**GEM-RP3DGTL**).

3. Press **INTERIOR** To Enter Dealer Program Mode

4. Press **RESET** To Exit Easy Menu Driven Program Mode & Enter Direct Address Program Mode

Direct Address Program Mode: Programming Options & Worksheets

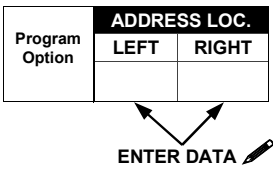

PROGRAMMING STEPS:

1. Lookup desired Programming Option by Address Location (highlighted in black).
2. Select the programming option data entry from the tables shown, by direct entry or by adding binary values.
3. Enter the selected data entry in the boxes shown.
4. For more information on a programming option refer to the Glossary at the end of this manual.

ENTRY TOTAL	PRESS	KEYPAD DISPLAYS
blank	<input type="text"/> 0	•
1	<input type="text"/> 1	1
2	<input type="text"/> 2	2
3	<input type="text"/> 3	3
4	<input type="text"/> 4	4
5	<input type="text"/> 5	5
6	<input type="text"/> 6	6
7	<input type="text"/> 7F	7
8	<input type="text"/> 8A	8
9	<input type="text"/> 9P	9
10	<input type="text"/> * <input type="text"/> 0	0
11	<input type="text"/> * <input type="text"/> 1	B
12	<input type="text"/> * <input type="text"/> 2	C
13	<input type="text"/> * <input type="text"/> 3	D
14	<input type="text"/> * <input type="text"/> 4	E
15	<input type="text"/> * <input type="text"/> 5	F

Determining data entry for a location (each "nibble"). Numbers in parentheses indicate data for selected zones or features. (See Programming Worksheets that follow.)

DEFAULTS: The defaults shown on the following pages are automatically set after exiting the Easy Menu Driven Mode.

SYSTEM DELAYS & TIMEOUTS (ADDRESS 0000-0002, 2402, 2406, 2414 & 3902)

EXIT DELAY (sec.)	ADDRESS 0000	
	LEFT	RIGHT

[Default = 3C]

ENTRY DELAY 1 (sec.)	ADDRESS 0001	
	LEFT	RIGHT

[Default = 1E]

ENTRY DELAY 2 (sec.)	ADDRESS 0002	
	LEFT	RIGHT

[Default = 1 E]

Aux. Output Access Control Timeout (sec.)	ADDRESS 2402	
	LEFT	RIGHT

[Default = blank (•) blank (•)]

ABORT DELAY (sec.)	ADDRESS 2406	
	LEFT	RIGHT

[Default = blank (•) blank (•)]

Telephone Line Test Delay (sec.)	ADDRESS 2414	
	LEFT	RIGHT

[Default = blank (•) blank (•)]

CS Telco 3 Report Delay (sec.)	ADDRESS 3902	
	LEFT	RIGHT

[Default = blank (•) blank (•)]

DATA ENTRIES		DELAY/ TIMEOUT
LEFT	RIGHT	
blank (•)	blank (•)	0 sec.
blank (•)	F	15 sec.
1	E	30 sec.
2	D	45 sec.
3	C	60 sec.
5	0	90 sec.
7	8	120 sec.
↓	↓	↓
F	F	255 sec.

1. Select delay/timeout (0-255 sec.) from the table shown.
2. Enter in corresponding address locations above (left and right digits).
3. For a desired delay/timeout not listed do the following:
 - Choose a desired delay/timeout, ex: 20 sec.
 - Divide it by 16

$$\begin{array}{r}
 \textcircled{1} \text{ Quotient} \longrightarrow \text{Left Digit} \\
 16 \overline{) 20} \\
 \underline{-16} \\
 \textcircled{4} \text{ Remainder} \longrightarrow \text{Right Digit}
 \end{array}$$

EXIT/ENTRY DELAYS: Apply only to zones programmed with the following options "Entry/Exit 1, Entry/Exit 2, Exit/Entry Follower". For UL Installations, the maximum exit delay is 60 seconds and the maximum entry delay is 45 seconds.

PROGRAMMING TIMEOUTS: Either use the tables provide or calculate your own timeout using the steps indicated.
WARNING: Timers have uncertainty of +/-1sec, so a "time" of 1 second may actually timeout IMMEDIATELY.

SYSTEM DELAYS & TIMEOUTS (ADDRESS 2407, 2408 & 4088)

CHIME TIMEOUT (1/4sec.)	ADDRESS 2407	
	LEFT	RIGHT

[Default = blank (•) 2]

AC Fail Report Delay (min.)	ADDRESS 2408	
	LEFT	RIGHT

[Default = blank (•) blank (•)]

Sensor Watch Delay (Hr.)	ADDRESS 4088	
	LEFT	RIGHT

[Default = blank (•) blank (•)]

CHIME TIMEOUT OPTIONS		
DATA ENTRIES		TIMEOUT
LEFT	RIGHT	
blank (•)	blank (•)	0 1/4sec. = 0 sec.
blank (•)	2	2 1/4sec. = 1/2 sec.
blank (•)	3	3 1/4sec. = 3/4 sec.
blank (•)	4	4 1/4sec. = 1 sec.
blank (•)	5	5 1/4sec. = 1.25 sec.
blank (•)	6	6 1/4sec. = 1.5 sec.
blank (•)	7	7 1/4sec. = 1.75 sec.
blank (•)	8	8 1/4sec. = 2 sec.
↓	↓	↓
F	F	255 1/4sec. = 63.25 sec.

AC FAIL REPORT DELAY OPTIONS		
DATA ENTRIES		DELAY
LEFT	RIGHT	
blank (•)	blank (•)	0 min.
blank (•)	1	10 min.
blank (•)	2	20 min.
blank (•)	3	30 min.
blank (•)	4	40 min.
blank (•)	5	50 min.
blank (•)	6	60 min.
blank (•)	7	70 min.
↓	↓	↓
F	F	2550 min. = 42 Hr., 30 min.

SENSOR WATCH OPTIONS		
DATA ENTRIES		DELAY
LEFT	RIGHT	
blank (•)	blank (•)	0 Hr.
blank (•)	1	1 Hr.
blank (•)	2	2 Hr.
blank (•)	3	3 Hr.
blank (•)	4	4 Hr.
blank (•)	5	5 Hr.
blank (•)	6	6 Hr.
blank (•)	7	7 Hr.
↓	↓	↓
F	F	255 Hr.

1. Select delay/timeout from the table shown.
2. Enter in corresponding address locations above (left and right digits).
3. For a desired delay/timeout not listed do the following:
 - Choose a desired delay/timeout , ex: 20. **Note:** For Sensor Watch only divide it by 10, ex: 20/10 = 2
 - Divide it by 16

$$\begin{array}{r}
 \textcircled{1} \text{ Quotient} \longrightarrow \text{Left Digit} \\
 16 \overline{) 20} \\
 \underline{-16} \\
 \textcircled{4} \text{ Remainder} \longrightarrow \text{Right Digit}
 \end{array}$$

SYSTEM DELAYS & TIMEOUTS (ADDRESS 2400, 2401, 2403-2405, 4082 & 4083)

Reset Output Timeout (min.)	ADDRESS 2400	
	LEFT	RIGHT

[Default = blank (*) blank (*)]

Aux. Output Timeout (min.)	ADDRESS 2401	
	LEFT	RIGHT

[Default = blank (*) blank (*)]

Burg. Alarm Output Timeout (min.)	ADDRESS 2403	
	LEFT	RIGHT

[Default = 1 blank (*)]

Pulse Alarm Output Timeout (min.)	ADDRESS 2404	
	LEFT	RIGHT

[Default = blank (*) 1]

Fire Output Timeout (min.)	ADDRESS 2405	
	LEFT	RIGHT

[Default = blank (*) blank (*)]

DATA ENTRIES		DELAY/TIMEOUT
LEFT	RIGHT	
blank (*)	blank (*)	0 min.
blank (*)	1	1 min.
blank (*)	2	2 min.
blank (*)	3	3 min.
blank (*)	4	4 min.
blank (*)	5	5 min.
blank (*)	6	6 min.
1	blank (*)	16 min.
↓	↓	↓
F	F	255 min.

1. Select delay/timeout (0-255 min.) from the table shown.
2. Enter in corresponding address locations above (left and right digits).
3. For a desired delay/timeout not listed do the following:
 - A. Choose a desired delay/timeout, ex: 20 min.
 - B. Divide it by 16

$$\begin{array}{r}
 \textcircled{1} \text{ Quotient} \longrightarrow \text{Left Digit} \\
 16 \overline{) 20} \\
 \underline{-16} \\
 \textcircled{4} \text{ Remainder} \longrightarrow \text{Right Digit}
 \end{array}$$

OUTPUT TIMEOUTS: If a timeout of "0 min." is selected, then the output will remain active (ON) until the system is reset or disarmed. For UL Residential Installations, the minimum timeout is 4 minutes. For UL Commercial Installations, the minimum timeout is 15 minutes.

Report Cancel Window (sec.)	ADDRESS 4082	
	LEFT	RIGHT

[Default = blank (*) blank (*)]

Auto Disarm Rearm Delay (min.)	ADDRESS 4083	
	LEFT	RIGHT

[Default = blank (*) blank (*)]

KEYPAD SYSTEM CODES (ADDRESS 0490, 0495 & 0500)

Panel Access Code	ADDRESS 0490-0492					
	0490		0491		0492	
	L	R	L	R	L	R

[Default = blank (*) blank (*) from address 0490-0492]

PANEL ACCESS CODE: Enter up to 6 digits to activate a door strike while the area is disarmed.

1. Enter in both left and right digits of address locations.
2. Valid entries are: 0-9.

Note: Also, "Access Control on Aux. Output" (Address 2418) and "Aux. Output Access Control Timeout" (Address 2402) must both be enabled.

Ambush Code	ADDRESS 0495	
	LEFT	RIGHT

[Default = blank (*) blank (*)]

AMBUSH CODE: Enter a 2-digit code used just prior to disarming and will activate an Ambush Condition, causing a SILENT report to be sent to the central station.

1. Enter in both left and right digits of address locations.
2. Valid entries are: 0-9.

Note: Also, "Enable Keypad Ambush" (Address 2440-2446), "Report on Ambush Alarm" (Address 1125, 1127, 1135 & 1137) and "Ambush Code" (Address 0900) must all be enabled.

Dealer Security Code	ADDRESS 0500-0502					
	0500		0501		0502	
	L	R	L	R	L	R

[Default = blank (*) blank (*) from address 0500-0502]

DEALER SECURITY CODE: Enter up to 6 digits to be used by the dealer to enter programming.

1. Enter in both left and right digits of address locations.
2. Valid entries are: 0-9.

Note: If left blank, the Master Security Code must then be used to enter programming.

CS RECEIVER FORMAT OPTIONS (ADDRESS 0520, 0521, 0525, 0526, 0550, 0551, 0575 & 0576)

CS Receiver 1 Format	ADDRESS 0525	
	LEFT	RIGHT

CS Receiver 2 Format	ADDRESS 0550	
	LEFT	RIGHT

CS Receiver 3 Format	ADDRESS 0575	
	LEFT	RIGHT

Default for CS Receiver 1 Format depends on Easy Menu Question "RCVR FORMAT". [Default = •(blank) •(blank)] for CS Receivers 2 and 3 Formats.

DATA ENTRIES		CS RECEIVER FORMATS
LEFT	RIGHT	
blank (*)	blank (*)	Ademco Slow, Silent Knight Slow
blank (*)	1	Sescoa, Vertex, DCI, Franklin Fast
blank (*)	2	Radionics Fast
blank (*)	3	Silent Knight Fast
blank (*)	4	Radionics, DCI, Franklin Slow
blank (*)	5	Universal High Speed
blank (*)	8	Radionics BFSK
blank (*)	9	FBI 4/3/1
blank (*)	0	Radionics Modem 2
blank (*)	B	SIA
blank (*)	C	Ademco Point ID
blank (*)	D	Ademco Express
blank (*)	E	Pager
1	blank (*)	Radionics Modem IIe

CS RECEIVER FORMATS: Up to 3 CS Formats may be programmed.

1. Select the desired CS Receiver Format from the table shown.
2. Enter in the corresponding left and right digit address locations for each CS Receiver.

NOTE: Dark shaded data value box shows option not available.

Leading Digits for Pager Format (1st Digit)	ADDRESS 0520	
	LEFT	RIGHT
	blank (*)	

[Default = blank (*) blank (*)]

Leading Digits for Pager Format (2nd Digit)	ADDRESS 0521	
	LEFT	RIGHT
	blank (*)	

[Default = blank (*) blank (*)]

LEADING DIGITS FOR PAGER FORMAT: In Pager Format reporting, the message typically begins with "00". However, for some pager services, this will cause the Pager's Voice Mail feature to activate. This option allows you to program these digits to any number desired. Typical Pager report is "003 022 1234", where 3 is the Event, 22 is the zone, and 1234 is the Subscriber ID number. For example, if the Leading Digits are programmed as "98", the Pager report will now appear as "983 022 1234".

1. Enter in 1st and 2nd Leading Digits in right digit only (left digit is not used) as shown.
2. Valid entries are: 0-9.

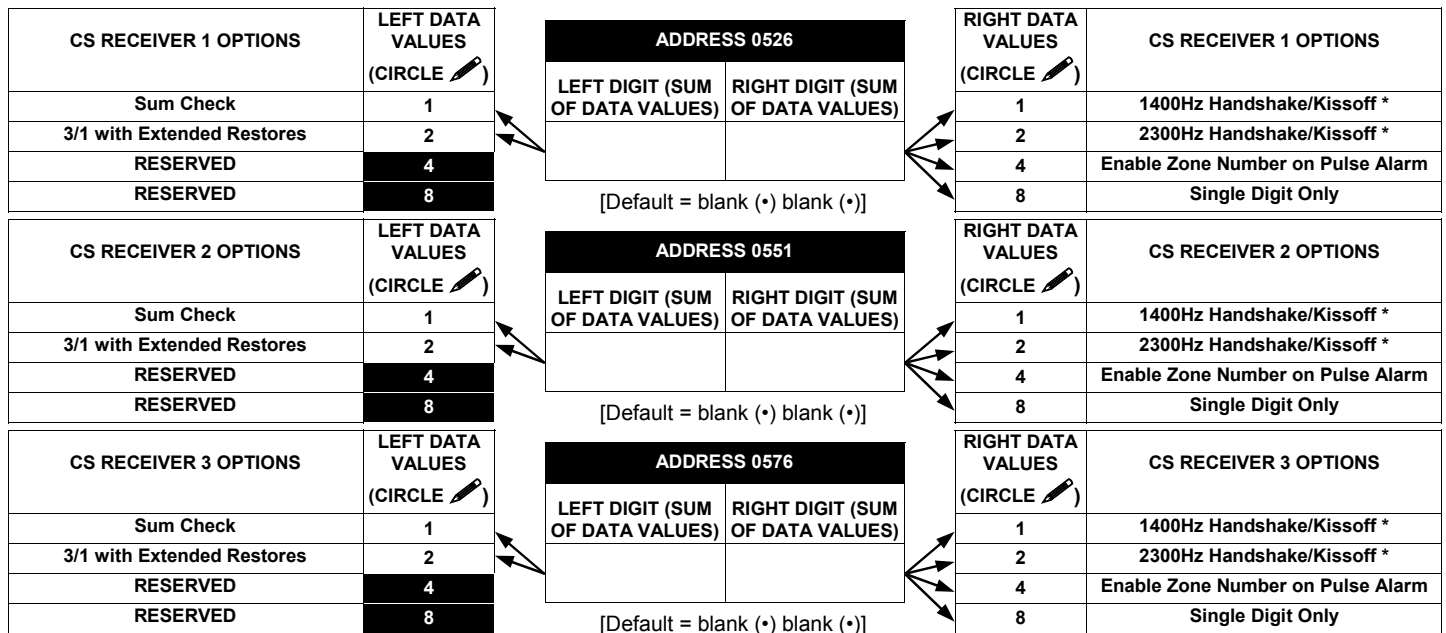

CS RECEIVER OPTIONS: Select options for any of the three CS Receivers.

1. Select the desired option by circling the data values for each digit (left and right).
2. Add the data values (ex: 15=1+2+4+8) from the selected options.
3. Enter in address location (left and right digits).

NOTE: Dark shaded data value box shows option not available.

NOTE: * If both are selected, 1400Hz has priority over 2300Hz.

CS RECEIVER TELEPHONE NUMBERS (ADDRESS 0527-0546, 0552-0571, 0577-0596)

CS Receiver 1 Telephone Number (Digits 1-20)	ADDRESS 0527-0546 (RIGHT DIGITS 1-20)																			
	0527	0528	0529	0530	0531	0532	0533	0534	0535	0536	0537	0538	0539	0540	0541	0542	0543	0544	0545	0546
	R	R	R	R	R	R	R	R	R	R	R	R	R	R	R	R	R	R	R	R

CS Receiver 2 Telephone Number (Digits 1-20)	ADDRESS 0552-0571 (RIGHT DIGITS 1-20)																			
	0552	0553	0554	0555	0556	0557	0558	0559	0560	0561	0562	0563	0564	0565	0566	0567	0568	0569	0570	0571
	R	R	R	R	R	R	R	R	R	R	R	R	R	R	R	R	R	R	R	R

CS Receiver 3 Telephone Number (Digits 1-20)	ADDRESS 0577-0596 (RIGHT DIGITS 1-20)																			
	0577	0578	0579	0580	0581	0582	0583	0584	0585	0586	0587	0588	0589	0590	0591	0592	0593	0594	0595	0596
	R	R	R	R	R	R	R	R	R	R	R	R	R	R	R	R	R	R	R	R

Default for CS Receiver 1 Telephone Number depends on Easy Menu Question "CENTRAL PHONE #".

[Default = blank (*)] across digits 1-20 for CS Receiver Telephone Numbers 2 and 3.

CS RECEIVER TELEPHONE NUMBERS: Enter telephone numbers for any of the three CS Receivers (Telco 1, 2 & 3).

1. Enter in right digit only (left digit is not used).
2. Enter up to 20 digits from left to right. **NOTE:** Leave trailing boxes blank (*).
3. Valid entries are: 1-9, B = button, C = button, D = 3 sec. pause, E = Wait for dial tone, F = ignore location

DOWNLOAD/CALLBACK OPTIONS (ADDRESS 4089, 0600-0619, 0625-0647, 1022 & 1023)

No. Rings Before Pickup	ADDRESS 4089	
	LEFT	RIGHT
		blank (*)

NUMBER OF RINGS BEFORE PICKUP: Enter the number of rings before automatic pickup by the control panel when downloading from a computer (see Glossary at the back for more information).

1. Enter in right digit only (left digit is not used).
2. Valid entries are: 1-9, 0 = 10, B = 11, C = 12, D = 13, E = 14, F = 15

NOTE: Default is 15 Rings. Dark shaded data shows option not available.

[Default = blank (*) F]

Callback Telephone Number 1 (Digits 1-20)	ADDRESS 0600-0619 (RIGHT DIGITS 1-20)																			
	0600	0601	0602	0603	0604	0605	0606	0607	0608	0609	0610	0611	0612	0613	0614	0615	0616	0617	0618	0619
	R	R	R	R	R	R	R	R	R	R	R	R	R	R	R	R	R	R	R	R

[Default = blank (*) for all digits 1-20]

Callback Telephone Number 2 (Digits 1-20)	ADDRESS 0625-0644 (RIGHT DIGITS 1-20)																			
	0625	0626	0627	0628	0629	0630	0631	0632	0633	0634	0635	0636	0637	0638	0639	0640	0641	0642	0643	0644
	R	R	R	R	R	R	R	R	R	R	R	R	R	R	R	R	R	R	R	R

[Default = blank (*) for all digits 1-20]

CALLBACK TELEPHONE NUMBERS: Enter telephone numbers to be used when downloading from a computer.

1. Enter in right digit only (left digit is not used).
2. Enter up to 20 digits from left to right. **NOTE:** Leave trailing boxes blank (*).
3. Valid entries are: 0-9, B = button, C = button, D = 3 sec. pause, E = Wait for dial tone, F = ignore location

Download Security Code	ADDRESS 0645-0647					
	0645		0646		0647	
	L	R	L	R	L	R

[Default = blank (*) blank (*)]

Callback Telephone No. Select	ADDRESS 1022	
	LEFT	RIGHT
		blank (*)

[Default = blank (*) blank (*)]

Auto Download ID No.	ADDRESS 1023	
	LEFT	RIGHT

Valid entries - 01-99

[Default = blank (*) blank (*)]

DOWNLOAD SECURITY CODE: Enter up to 6 digits to be used for remote access when downloading from a computer.

1. Enter in both left and right digits of address locations.
2. Valid entries are: 0-9.

Note: Download Security Code must match the code entered in the PCD3000 Software.

CALLBACK TELEPHONE NO. SELECT: Enter either "1" for Callback Telephone Number 1 or "2" for Callback Telephone Number 2.

1. Enter in right digit only (left digit is not used).
2. Valid entries are: 1 or 2.

CS SUBSCRIBER ID NUMBERS (ADDRESS 0650-0787)

CS TELCO 1 SUBSCRIBER OPENING/CLOSING ID NUMBERS

AREA 1			
ADDRESS 0650-0653 (RIGHT DIGITS 1-4)			
0650	0651	0652	0653
R	R	R	R

AREA 2			
ADDRESS 0654-0657 (RIGHT DIGITS 1-4)			
0654	0655	0656	0657
R	R	R	R

CS TELCO 1 SUBSCRIBER EVENT ID NUMBERS

AREA 1			
ADDRESS 0682-0685 (RIGHT DIGITS 1-4)			
0682	0683	0684	0685
R	R	R	R

AREA 2			
ADDRESS 0686-0689 (RIGHT DIGITS 1-4)			
0686	0687	0688	0689
R	R	R	R

SYSTEM			
ADDRESS 0714-0717 (RIGHT DIGITS 1-4)			
0714	0715	0716	0717
R	R	R	R

CS TELCO 2 SUBSCRIBER OPENING/CLOSING ID NUMBERS (BACKUP REPORTING)

AREA 1			
ADDRESS 0720-0723 (RIGHT DIGITS 1-4)			
0720	0721	0722	0723
R	R	R	R

AREA 2			
ADDRESS 0724-0727 (RIGHT DIGITS 1-4)			
0724	0725	0726	0727
R	R	R	R

CS TELCO 2 SUBSCRIBER EVENT ID NUMBERS (BACKUP REPORTING)

AREA 1			
ADDRESS 0752-0755 (RIGHT DIGITS 1-4)			
0752	0753	0754	0755
R	R	R	R

AREA 2			
ADDRESS 0756-0759 (RIGHT DIGITS 1-4)			
0756	0757	0758	0759
R	R	R	R

SYSTEM			
ADDRESS 0784-0787 (RIGHT DIGITS 1-4)			
0784	0785	0786	0787
R	R	R	R

CS Subscriber ID Numbers (TELCO 1 & 2)



CS SUBSCRIBER ID NUMBERS (ADDRESS 0790-0857)

CS TELCO 3 SUBSCRIBER OPENING/CLOSING ID NUMBERS

AREA 1			
ADDRESS 0790-0793 (RIGHT DIGITS 1-4)			
0790	0791	0792	0793
R	R	R	R

AREA 2			
ADDRESS 0794-0797 (RIGHT DIGITS 1-4)			
0794	0795	0796	0797
R	R	R	R

CS TELCO 3 SUBSCRIBER EVENT ID NUMBERS

AREA 1			
ADDRESS 0822-0825 (RIGHT DIGITS 1-4)			
0822	0823	0824	0825
R	R	R	R

AREA 2			
ADDRESS 0826-0829 (RIGHT DIGITS 1-4)			
0826	0827	0828	0829
R	R	R	R

SYSTEM			
ADDRESS 0854-0857 (RIGHT DIGITS 1-4)			
0854	0855	0856	0857
R	R	R	R

Default for CS Telco 1 Subscriber Event ID Number (Area 1) depends on Easy Menu Question "ACCOUNT #". [Default = blank (•) blank (•) blank (•) blank (•)] for all other ID Numbers.

CS TELCO SUBSCRIBER ID NUMBERS: Enter the Subscriber Opening/Closing and Event ID Numbers for any of the 3 CS Receivers.

1. Enter in corresponding right digit address location (left digit is not used).
2. Enter 3 or 4 digits (depending on the CS receiver format) for each subscriber number from left to right.
NOTE: Leave trailing boxes blank (•).
3. Valid entries are: 0-9, 0 and B-F.

CS REPORTING CODES (ADDRESS 0859-0869)

ALARM/TROUBLE REPORTING CODES	ADDRESS 0860-0862		
	LEFT	ADDR	RIGHT
Cancel	blank (•)	0859	
Alarm Restore	blank (•)	0860	
Trouble	blank (•)	0861	
Trouble Restore	blank (•)	0862	

[Default = blank (•) blank (•) from address 0859-0869]

OPENING/CLOSING REPORTING CODES	ADDRESS 0864-0869		
	LEFT	ADDR	RIGHT
Closing	blank (•)	0864	
Conditional Closing	blank (•)	0865	
Opening	blank (•)	0866	
Opening after Alarm	blank (•)	0867	
Fail to Close		0868	
Fail to Open		0869	

CS REPORTING CODES:

1. Enter in corresponding address location (left and right digits).
2. Valid entries are: 1-9, 0 and B-F.

NOTE: Dark shaded data value box shows option not available.

CS REPORTING CODES (ADDRESS 0870-0904)



SYSTEM REPORTING CODES	ADDRESS 0870-0880		
	LEFT	ADDR	RIGHT
Test Timer		0870	
Alarm Supervisory		0871	
Bus Failure		0872	
Memory Failure		0873	
Panel Low Battery		0874	
Panel AC Failure		0875	
EZM Tamper		0876	
Sensor Watch		0877	
RESERVED	blank (*)	0878	blank (*)
RESERVED	blank (*)	0879	blank (*)
Telco Line Failure		0880	

SYSTEM REPORTING CODES	ADDRESS 0890-0897		
	LEFT	ADDR	RIGHT
Digital Dialer Test		0890	
RESERVED	blank (*)	0891	blank (*)
RESERVED	blank (*)	0892	blank (*)
Service Message		0893	
Program Change		0894	
RF Receiver Trouble		0895	
RF Receiver Tamper		0896	
RF Trouble		0897	

KEYPAD REPORTING CODES	ADDRESS 0900-0904		
	LEFT	ADDR	RIGHT
Ambush		0900	
Panic		0901	
Fire		0902	
Auxiliary		0903	
Tamper		0904	

[Default = blank (*) blank (*) from address 0870-0904]

CS REPORTING CODES:

-  1. Enter in corresponding address location (left and right digits).
-  2. Valid entries are: 1-9, 0 and B-F.

NOTE: Dark shaded data value box shows option not available.

CAUTION: For all 2-Digit Reporting Formats (see CS Receiver Format Options), use the following:

Reporting Code	ADDRESS LOC.	
	LEFT	RIGHT
	1	2

2nd Digit of Reporting Code 



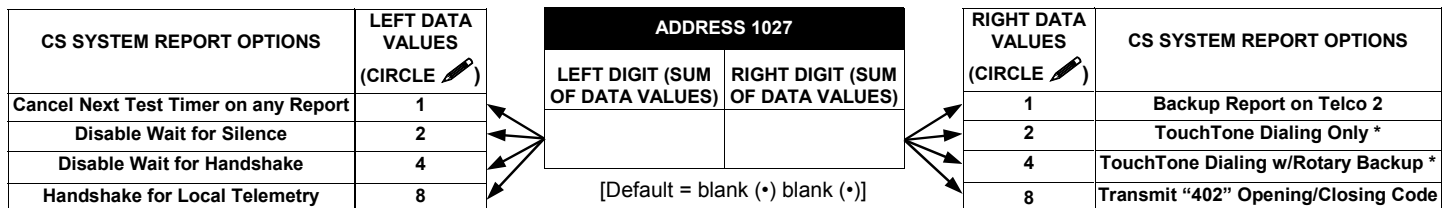
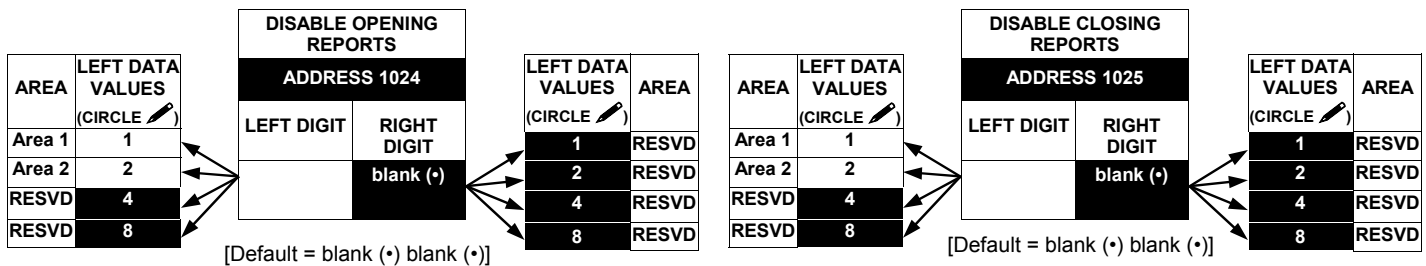

1st Digit of Reporting Code 

Example: The 2-digit reporting code as shown is "21".

CS AREA & SYSTEM REPORTING OPTIONS (ADDRESS 1024-1027)



CS AREA & SYSTEM REPORTING OPTIONS:

-  1. Select the desired option by circling  the data values for each digit (left and right).
-  2. Add the data values (ex: 15=1+2+4+8) from the selected options.
-  3. Enter in address location (left and right digits).

NOTE: Dark shaded data value box shows option not available.

*** NOTE:** If neither TouchTone Dialing nor TouchTone w/Rotary Backup is selected, then system defaults automatically to Rotary Dialing. Leave blank (*) to select Rotary Dialing.



CS ZONE REPORTING CODES (ADDRESS 0910-0957)

ADDRESS 0910-0917							
ZONES REPORT CODE (CONTROL PANEL)							
ZONE 1		ZONE 2		ZONE 3		ZONE 4	
0910	0911	0912	0913	0914	0915	0916	0917
L	R	L	R	L	R	L	R

ADDRESS 0918-0921			
ZONES REPORT CODE (GROUP 1)			
ZONE 9		ZONE 10	
0918	0919	0920	0921
L	R	L	R

ADDRESS 0922-0925			
ZONES REPORT CODE (GROUP 2)			
ZONE 13		ZONE 14	
0922	0923	0924	0925
L	R	L	R

ADDRESS 0926-0929			
ZONES REPORT CODE (GROUP 3)			
ZONE 17		ZONE 18	
0926	0927	0928	0929
L	R	L	R

ADDRESS 0930-0933			
ZONES REPORT CODE (GROUP 4)			
ZONE 21		ZONE 22	
0930	0931	0932	0933
L	R	L	R

ADDRESS 0934-0937			
ZONES REPORT CODE (GROUP 5)			
ZONE 25		ZONE 26	
0934	0935	0936	0937
L	R	L	R

ADDRESS 0938-0941			
ZONES REPORT CODE (GROUP 6)			
ZONE 29		ZONE 30	
0938	0939	0940	0941
L	R	L	R

ADDRESS 0942-0945			
ZONES REPORT CODE (GROUP 7)			
ZONE 33		ZONE 34	
0942	0943	0944	0945
L	R	L	R

ADDRESS 0946-0949			
ZONES REPORT CODE (GROUP 8)			
ZONE 37		ZONE 38	
0946	0947	0948	0949
L	R	L	R

ADDRESS 0950-0953			
ZONES REPORT CODE (GROUP 9)			
ZONE 41		ZONE 42	
0950	0951	0952	0953
L	R	L	R

ADDRESS 0954-0957			
ZONES REPORT CODE (GROUP 10)			
ZONE 45		ZONE 46	
0954	0955	0956	0957
L	R	L	R

CS Zone Reporting Codes

Default for Group Zone Report Codes depends on Easy Menu Question "RCVR."

ZONE REPORT CODE OPTIONS	
DATA ENTRIES	
LEFT	RIGHT

NOTE: Zones 1-8 are included in the control panel and Zones 9-48 are EZM Zones. See Address 2600-2605 to enable "EZM Zone Groups".

DATA ENTRIES	MODEM CODE
LEFT	
1	Fire *
2	Panic
3	Burglary
4	Hold up
7	Gas Alarm
8	Heat Alarm
0	Auxiliary Alarm
B	24 Hour Auxiliary

PULSE EVENT CODE will be the first digit of the 2 digit reporting code. the second digit will be the second digit of the reporting zone. For example, for zone 9 (address 0918), if the right digit is "3", then the reporting code is "39". For example, for zone 15 (address 0924), if the right digit is "4", then the reporting code is "45".

MODEM CODES determine the zone types reported for the following formats: SIA and ADEMCO Point ID.

1. Select the desired Modem Code for each zone from the table shown.

CS USER REPORTING CODES (ADDRESS 1030-1055)

User Opening Telco 1	LEFT DATA VALUES				ADDRESS 1031		RIGHT DATA VALUES				LEFT DATA VALUES				ADDRESS 1030		RIGHT DATA VALUES			
	User 16	User 15	User 14	User 13	LEFT	RIGHT	User 12	User 11	User 10	User 9	User 8	User 7	User 6	User 5	LEFT	RIGHT	User 4	User 3	User 2	User 1
	8	4	2	1			8	4	2	1	8	4	2	1			8	4	2	1
User Opening Telco 1	LEFT DATA VALUES				ADDRESS 1033		RIGHT DATA VALUES				LEFT DATA VALUES				ADDRESS 1032		RIGHT DATA VALUES			
	User 32	User 31	User 30	User 29	LEFT	RIGHT	User 28	User 27	User 26	User 25	User 24	User 23	User 22	User 21	LEFT	RIGHT	User 20	User 19	User 18	User 17
	8	4	2	1			8	4	2	1	8	4	2	1			8	4	2	1
User Opening Telco 1	LEFT DATA VALUES				ADDRESS 1035		RIGHT DATA VALUES				LEFT DATA VALUES				ADDRESS 1034		RIGHT DATA VALUES			
	User 48	User 47	User 46	User 45	LEFT	RIGHT	User 44	User 43	User 42	User 41	User 40	User 39	User 38	User 37	LEFT	RIGHT	User 36	User 35	User 34	User 33
	8	4	2	1			8	4	2	1	8	4	2	1			8	4	2	1
User Opening Telco 1	ADDRESS 1042		RIGHT DATA VALUES																	
	LEFT	RIGHT	User 00	User 99	User 98	User 97														
	blank (+)		8	4	2	1														

User 97 = Auto Arming/Disarming
 User 98 = Quickloader Arming/Disarming
 User 99 = Easy Arming (Opening not applicable)
 User 00 = Keyswitch Arming

NOTE: These opening events will report as the user number shown. Also, Keyfobs 1-8 (see Easy Menu Program Driven Mode) will report as Users 25-32, respectively.

User Closing Telco 1	LEFT DATA VALUES				ADDRESS 1044		RIGHT DATA VALUES				LEFT DATA VALUES				ADDRESS 1043		RIGHT DATA VALUES			
	User 16	User 15	User 14	User 13	LEFT	RIGHT	User 12	User 11	User 10	User 9	User 8	User 7	User 6	User 5	LEFT	RIGHT	User 4	User 3	User 2	User 1
	8	4	2	1			8	4	2	1	8	4	2	1			8	4	2	1
User Closing Telco 1	LEFT DATA VALUES				ADDRESS 1046		RIGHT DATA VALUES				LEFT DATA VALUES				ADDRESS 1045		RIGHT DATA VALUES			
	User 32	User 31	User 30	User 29	LEFT	RIGHT	User 28	User 27	User 26	User 25	User 24	User 23	User 22	User 21	LEFT	RIGHT	User 20	User 19	User 18	User 17
	8	4	2	1			8	4	2	1	8	4	2	1			8	4	2	1
User Closing Telco 1	LEFT DATA VALUES				ADDRESS 1048		RIGHT DATA VALUES				LEFT DATA VALUES				ADDRESS 1047		RIGHT DATA VALUES			
	User 48	User 47	User 46	User 45	LEFT	RIGHT	User 44	User 43	User 42	User 41	User 40	User 39	User 38	User 37	LEFT	RIGHT	User 36	User 35	User 34	User 33
	8	4	2	1			8	4	2	1	8	4	2	1			8	4	2	1
User Closing Telco 1	ADDRESS 1055		RIGHT DATA VALUES																	
	LEFT	RIGHT	User 00	User 99	User 98	User 97														
	blank (+)		8	4	2	1														

User 97 = Auto Arming/Disarming
 User 98 = Quickloader Arming/Disarming
 User 99 = Easy Arming (Opening not applicable)
 User 00 = Keyswitch Arming

NOTE: These opening events will report as the user number shown. Also, Keyfobs 1-8 (see Easy Menu Program Driven Mode) will report as Users 25-32, respectively.



CS USER REPORTING CODES (ADDRESS 1056-1081)

User Opening Telco 3	LEFT DATA VALUES				ADDRESS 1057		RIGHT DATA VALUES				LEFT DATA VALUES				ADDRESS 1056		RIGHT DATA VALUES			
	User 16	User 15	User 14	User 13	LEFT	RIGHT	User 12	User 11	User 10	User 9	User 8	User 7	User 6	User 5	LEFT	RIGHT	User 4	User 3	User 2	User 1
	8	4	2	1			8	4	2	1	8	4	2	1			8	4	2	1

User Opening Telco 3	LEFT DATA VALUES				ADDRESS 1059		RIGHT DATA VALUES				LEFT DATA VALUES				ADDRESS 1058		RIGHT DATA VALUES			
	User 32	User 31	User 30	User 29	LEFT	RIGHT	User 28	User 27	User 26	User 25	User 24	User 23	User 22	User 21	LEFT	RIGHT	User 20	User 19	User 18	User 17
	8	4	2	1			8	4	2	1	8	4	2	1			8	4	2	1

User Opening Telco 3	LEFT DATA VALUES				ADDRESS 1061		RIGHT DATA VALUES				LEFT DATA VALUES				ADDRESS 1060		RIGHT DATA VALUES			
	User 48	User 47	User 46	User 45	LEFT	RIGHT	User 44	User 43	User 42	User 41	User 40	User 39	User 38	User 37	LEFT	RIGHT	User 36	User 35	User 34	User 33
	8	4	2	1			8	4	2	1	8	4	2	1			8	4	2	1

User Opening Telco 3	ADDRESS 1068		RIGHT DATA VALUES			
	LEFT	RIGHT	User 00	User 99	User 98	User 97
	blank (*)		8	4	2	1

User 97 = Auto Arming/Disarming
 User 98 = Quickloader Arming/Disarming
 User 99 = Easy Arming (Opening not applicable)
 User 00 = Keyswitch Arming

NOTE: These opening events will report as the user number shown. Also, Keyfobs 1-8 (see Easy Menu Program Driven Mode) will report as Users 25-32, respectively.

CS User Reporting Codes

User Closing Telco 3	LEFT DATA VALUES				ADDRESS 1070		RIGHT DATA VALUES				LEFT DATA VALUES				ADDRESS 1069		RIGHT DATA VALUES			
	User 16	User 15	User 14	User 13	LEFT	RIGHT	User 12	User 11	User 10	User 9	User 8	User 7	User 6	User 5	LEFT	RIGHT	User 4	User 3	User 2	User 1
	8	4	2	1			8	4	2	1	8	4	2	1			8	4	2	1

User Closing Telco 3	LEFT DATA VALUES				ADDRESS 1072		RIGHT DATA VALUES				LEFT DATA VALUES				ADDRESS 1071		RIGHT DATA VALUES			
	User 32	User 31	User 30	User 29	LEFT	RIGHT	User 28	User 27	User 26	User 25	User 24	User 23	User 22	User 21	LEFT	RIGHT	User 20	User 19	User 18	User 17
	8	4	2	1			8	4	2	1	8	4	2	1			8	4	2	1



User Closing Telco 3	LEFT DATA VALUES				ADDRESS 1074		RIGHT DATA VALUES				LEFT DATA VALUES				ADDRESS 1073		RIGHT DATA VALUES			
	User 48	User 47	User 46	User 45	LEFT	RIGHT	User 44	User 43	User 42	User 41	User 40	User 39	User 38	User 37	LEFT	RIGHT	User 36	User 35	User 34	User 33
	8	4	2	1			8	4	2	1	8	4	2	1			8	4	2	1

User Closing Telco 3	ADDRESS 1081		RIGHT DATA VALUES			
	LEFT	RIGHT	User 00	User 99	User 98	User 97
	blank (*)		8	4	2	1



User 97 = Auto Arming/Disarming
 User 98 = Quickloader Arming/Disarming
 User 99 = Easy Arming (Opening not applicable)
 User 00 = Keyswitch Arming

NOTE: These opening events will report as the user number shown. Also, Keyfobs 1-8 (see Easy Menu Program Driven Mode) will report as Users 25-32, respectively.



GLOBAL SYSTEM TROUBLE REPORTING OPTIONS (ADDRESS 1082-1116)

SYSTEM RESPONSE ACTIVATED BY GLOBAL EVENT/TROUBLE	GLOBAL SYSTEM EVENT/TROUBLE				ADDRESS 1082-1092			GLOBAL SYSTEM EVENT/TROUBLE			
	LEFT DATA VALUES (CIRCLE )							RIGHT DATA VALUES (CIRCLE )			
	SENSOR WATCH	EZM TAMPER	AC FAIL	LOW BATTERY	LEFT	ADDR	RIGHT	MEMORY FAILURE	COMM. BUS 1	ALARM SUPERV.	TEST TIMER
Burglary Alarm Output	8	4	2	1		1082		8	4	2	1
Pulsed Burg. Output	8	4	2	1		1083		8	4	2	1
Fire Output	8	4	2	1		1084		8	4	2	1
Reset Relay	8	4	2	1		1085		8	4	2	1
Auxiliary Relay	8	4	2	1		1086		8	4	2	1
Report Event Telco 1	8	4	2	1		1087		8	4	2	1
Report Restore Telco 1	8	4	2	1		1088		8	4	2	1
Report Event Telco 3	8	4	2	1		1091		8	4	2	1
Report Restore Telco 3	8	4	2	1		1092		8	4	2	1





See NOTE  [Default = blank (•) blank (•) from address 1082-1092]

SYSTEM RESPONSE ACTIVATED BY GLOBAL EVENT/TROUBLE	GLOBAL SYSTEM EVENT/TROUBLE				ADDRESS 1094-1104			GLOBAL SYSTEM EVENT/TROUBLE			
	LEFT DATA VALUES (CIRCLE )							RIGHT DATA VALUES (CIRCLE )			
	RSRVD.	RSRVD.	RSRVD.	RSRVD.	LEFT	ADDR	RIGHT	Telemetry Failure	Telemetry Trouble	RSRVD.	TELCO FAIL
Burglary Alarm Output	8	4	2	1	blank (•)	1094		8	4	2	1
Pulsed Burg. Output	8	4	2	1	blank (•)	1095		8	4	2	1
Fire Output	8	4	2	1	blank (•)	1096		8	4	2	1
Reset Relay	8	4	2	1	blank (•)	1097		8	4	2	1
Auxiliary Relay	8	4	2	1	blank (•)	1098		8	4	2	1
Report Event Telco 1	8	4	2	1	blank (•)	1099		8	4	2	1
Report Restore Telco 1	8	4	2	1	blank (•)	1100		8	4	2	1
Report Event Telco 3	8	4	2	1	blank (•)	1103		8	4	2	1
Report Restore Telco 3	8	4	2	1	blank (•)	1104		8	4	2	1

[Default = blank (•) blank (•) from address 1094-1104]

SYSTEM RESPONSE ACTIVATED BY GLOBAL EVENT/TROUBLE	GLOBAL SYSTEM EVENT/TROUBLE				ADDRESS 1106-1116			GLOBAL SYSTEM EVENT/TROUBLE			
	LEFT DATA VALUES (CIRCLE )							RIGHT DATA VALUES (CIRCLE )			
	RF TROUBLE	RF TAMPER	RF RCVR. TROUBLE	PROGRAM CHANGE	LEFT	ADDR	RIGHT	SERVICE MESSAGE	RSRVD.	RSRVD.	Digital Dialer Test
Burglary Alarm Output	8	4	2	1		1106	blank (•)	8	4	2	1
Pulsed Burg. Output	8	4	2	1		1107	blank (•)	8	4	2	1
Fire Output	8	4	2	1		1108	blank (•)	8	4	2	1
Reset Relay	8	4	2	1		1109	blank (•)	8	4	2	1
Auxiliary Relay	8	4	2	1		1110	blank (•)	8	4	2	1
Report Event Telco 1	8	4	2	1		1111		8	4	2	1
Report Restore Telco 1	8	4	2	1	blank (•)	1112	blank (•)	8	4	2	1
Report Event Telco 3	8	4	2	1		1115		8	4	2	1
Report Restore Telco 3	8	4	2	1	blank (•)	1116	blank (•)	8	4	2	1

See NOTE  [Default = blank (•) blank (•) from address 1106-1116]

-  1. Select the desired option by circling  the data values for each digit (left and right).
-  2. Add the data values (ex: 15=1+2+4+8) from the selected options.
-  3. Enter in address location (left and right digits).

NOTE: Dark shaded data value box shows option not available.



AREA SYSTEM TROUBLE REPORTING OPTIONS (ADDRESS 1120-1157)

AREA 1	SYSTEM RESPONSE ACTIVATED BY AREA 1 EVENT/TROUBLE	AREA 1 SYSTEM EVENT/TROUBLE				ADDRESS 1120-1127			AREA 1 SYSTEM EVENT/TROUBLE			
		LEFT DATA VALUES (CIRCLE)				LEFT	ADDR	RIGHT	RIGHT DATA VALUES (CIRCLE)			
		RSRVD.	FAIL TO CLOSE	FAIL TO OPEN	KEYPAD TAMPER				KEYPAD AUX.	KEYPAD FIRE	KEYPAD PANIC	AMBUSH
	Pulsed Burg. Output	8	4	2	1		1120		8	④	2	1
	Burglary Output	8	4	2	1		1121		⑧	4	②	1
	Fire Output	8	4	2	1		1122		8	4	2	1
	Reset Relay	8	4	2	1		1123		8	4	2	1
	Auxiliary Relay	8	4	2	1		1124		8	4	2	1
	Report Alarm Telco 1	8	4	2	1		1125		⑧	④	②	1
	Report Alarm Telco 3	8	4	2	1		1127		8	4	2	1

[Defaults as circled from address 1120-1127]

AREA 2	SYSTEM RESPONSE ACTIVATED BY AREA 2 EVENT/TROUBLE	AREA 2 SYSTEM EVENT/TROUBLE				ADDRESS 1130-1137			AREA 2 SYSTEM EVENT/TROUBLE			
		LEFT DATA VALUES (CIRCLE)				LEFT	ADDR	RIGHT	RIGHT DATA VALUES (CIRCLE)			
		RSRVD.	FAIL TO CLOSE	FAIL TO OPEN	KEYPAD TAMPER				KEYPAD AUX.	KEYPAD FIRE	KEYPAD PANIC	AMBUSH
	Pulsed Burg. Output	8	4	2	1		1130		8	4	2	1
	Burglary Output	8	4	2	1		1131		8	4	2	1
	Fire Output	8	4	2	1		1132		8	4	2	1
	Reset Relay	8	4	2	1		1133		8	4	2	1
	Auxiliary Relay	8	4	2	1		1134		8	4	2	1
	Report Alarm Telco 1	8	4	2	1		1135		8	4	2	1
	Report Alarm Telco 3	8	4	2	1		1137		8	4	2	1

[Default = blank (•) blank (•) from address 1130-1137]

1. Select the desired option by circling the data values for each digit (left and right).

 2. Add the data values (ex: 15=1+2+4+8) from the selected options.

ZONE OPTIONS / ZONES 1-16 (ADDRESS 1200-1386)

ZONE OPTIONS	ZONES 13-16 LEFT DATA VALUES (CIRCLE)				ADDRESS 1302-1386			ZONES 9-12 RIGHT DATA VALUES (CIRCLE)				ZONES 5-8 LEFT DATA VALUES (CIRCLE)				ADDRESS 1200-1286			ZONES 1-4 RIGHT DATA VALUES (CIRCLE)			
	ZN16	ZN15	ZN14	ZN13	L	ADDR	R	ZN12	ZN11	ZN10	ZN9	ZN8	ZN7	ZN6	ZN5	L	ADDR	R	ZN4	ZN3	ZN2	ZN1
	50ms Loop Response (A)	8	4	2	1	(+)		(+)	8	4	2	1	8	4	2	1		1200		8	4	2
20ms Loop Response (A)	8	4	2	1	(+)		(+)	8	4	2	1	8	4	2	1		1201		8	4	2	1
Priority	8	4	2	1		1302		8	4	2	1	8	4	2	1		1202		8	4	2	1
Priority with Bypass	8	4	2	1		1303		8	4	2	1	8	4	2	1		1203		8	4	2	1
Auto-Bypass	8	4	2	1		1304		8	4	2	1	8	4	2	1		1204		8	4	2	1
Selective Bypass	8	4	2	1		1305		8	4	2	1	8	4	2	1		1205		8	4	2	1
Keyswitch Arming	8	4	2	1		1306		8	4	2	1	8	4	2	1		1206		8	4	2	1
Auto-Bypass Re-entry	8	4	2	1		1307		8	4	2	1	8	4	2	1		1207		8	4	2	1
Pre-Alarm Warning	8	4	2	1		1308		8	4	2	1	8	4	2	1		1208		8	4	2	1
Never Arm	8	4	2	1		1309		8	4	2	1	8	4	2	1		1209		8	4	2	1
24-Hour Zone	8	4	2	1		1310		8	4	2	1	8	4	2	1		1210		8	4	2	1
Burg. Alarm Output	8	4	2	1		1311		8	4	2	1	8	4	2	1		1211		8	4	2	1
Pulsed Alarm Output	8	4	2	1		1312		8	4	2	1	8	4	2	1		1212		8	4	2	1
Fire Output (Lug E9)	8	4	2	1		1313		8	4	2	1	8	4	2	1		1213		8	4	2	1
Reset Relay	8	4	2	1		1314		8	4	2	1	8	4	2	1		1214		8	4	2	1
Auxiliary Relay	8	4	2	1		1315		8	4	2	1	8	4	2	1		1215		8	4	2	1
Entry/Exit 1	8	4	2	1		1316		8	4	2	1	8	4	2	1		1216		8	4	2	1
Entry/Exit 2	8	4	2	1		1317		8	4	2	1	8	4	2	1		1217		8	4	2	1
Exit/Entry Follower	8	4	2	1		1318		8	4	2	1	8	4	2	1		1218		8	4	2	1
Auto Reset	8	4	2	1		1319		8	4	2	1	8	4	2	1		1219		8	4	2	1
Swinger Shutdown	8	4	2	1		1320		8	4	2	1	8	4	2	1		1220		8	4	2	1
Chime	8	4	2	1		1321		8	4	2	1	8	4	2	1		1221		8	4	2	1
Abort Delay	8	4	2	1		1322		8	4	2	1	8	4	2	1		1222		8	4	2	1
Power-up Delay	8	4	2	1		1323		8	4	2	1	8	4	2	1		1223		8	4	2	1
Day Zone Open	8	4	2	1		1324		8	4	2	1	8	4	2	1		1224		8	4	2	1
Day Zone Short	8	4	2	1		1325		8	4	2	1	8	4	2	1		1225		8	4	2	1
Alarm on Day Zone	8	4	2	1		1326		8	4	2	1	8	4	2	1		1226		8	4	2	1
Alarm Telco 1	8	4	2	1		1327		8	4	2	1	8	4	2	1		1227		8	4	2	1
Alarm Restore 1	8	4	2	1		1328		8	4	2	1	8	4	2	1		1228		8	4	2	1
Trouble Telco 1	8	4	2	1		1329		8	4	2	1	8	4	2	1		1229		8	4	2	1
Trouble Restore 1	8	4	2	1		1330		8	4	2	1	8	4	2	1		1230		8	4	2	1
Alarm Telco 3	8	4	2	1		1335		8	4	2	1	8	4	2	1		1235		8	4	2	1
Alarm Restore 3	8	4	2	1		1336		8	4	2	1	8	4	2	1		1236		8	4	2	1
Trouble Telco 3	8	4	2	1		1337		8	4	2	1	8	4	2	1		1237		8	4	2	1
Trouble Restore 3	8	4	2	1		1338		8	4	2	1	8	4	2	1		1238		8	4	2	1
No EOL Resistor	8	4	2	1		1339		8	4	2	1	8	4	2	1		1239		8	4	2	1
Sensor Watch	8	4	2	1		1340		8	4	2	1	8	4	2	1		1240		8	4	2	1
Trouble on Open	8	4	2	1		1341		8	4	2	1	8	4	2	1		1241		8	4	2	1
Trouble on Short	8	4	2	1		1342		8	4	2	1	8	4	2	1		1242		8	4	2	1
Trouble on Night Open	8	4	2	1		1343		8	4	2	1	8	4	2	1		1243		8	4	2	1
Zone Area 1	8	4	2	1		1344		8	4	2	1	8	4	2	1		1244		8	4	2	1
Zone Area 2	8	4	2	1		1345		8	4	2	1	8	4	2	1		1245		8	4	2	1
2-Wire Smoke Detectors (B)	8	4	2	1	(+)		(+)	8	4	2	1	8	4	2	1		1252	(+)	8	4	2	1
Zone ANDing Group 1	8	4	2	1		1354		8	4	2	1	8	4	2	1		1254		8	4	2	1
Zone ANDing Group 2	8	4	2	1		1355		8	4	2	1	8	4	2	1		1255		8	4	2	1
Interior #1 Bypass	8	4	2	1		1362		8	4	2	1	8	4	2	1		1262		8	4	2	1
Keypad Sounder on Alarm	8	4	2	1		1364		8	4	2	1	8	4	2	1		1264		8	4	2	1
Fire (C)	8	4	2	1		1375		8	4	2	1	8	4	2	1		1275		8	4	2	1
Fire Alarm Verification (C)	8	4	2	1		1376		8	4	2	1	8	4	2	1		1276		8	4	2	1
Chime 2	8	4	2	1		1386		8	4	2	1	8	4	2	1		1286		8	4	2	1

Zone Options / Zones 1-16

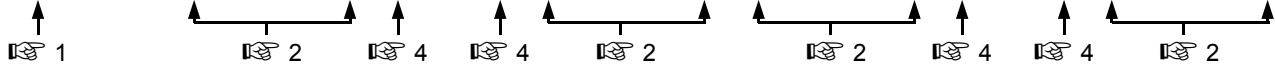

See Zone Options on Page 50.



ZONE OPTIONS / ZONES 17-32 (ADDRESS 1402-1586)

Zone Options / Zones 17-32

ZONE OPTIONS	ZONES 29-32 LEFT DATA VALUES				ADDRESS 1502-1586			ZONES 25-28 RIGHT DATA VALUES				ZONES 21-24 LEFT DATA VALUES				ADDRESS 1402-1486			ZONES 17-20 RIGHT DATA VALUES					
	(CIRCLE)				L	ADDR	R	(CIRCLE)				(CIRCLE)				L	ADDR	R	(CIRCLE)					
	ZN32	ZN31	ZN30	ZN29				ZN28	ZN27	ZN26	ZN25	ZN24	ZN23	ZN22	ZN21				ZN20	ZN19	ZN18	ZN17		
✓ Priority	8	4	2	1		1502			8	4	2	1	8	4	2	1		1402			8	4	2	1
Priority with Bypass	8	4	2	1		1503			8	4	2	1	8	4	2	1		1403			8	4	2	1
Auto-Bypass	8	4	2	1		1504			8	4	2	1	8	4	2	1		1404			8	4	2	1
✓ Selective Bypass	8	4	2	1		1505			8	4	2	1	8	4	2	1		1405			8	4	2	1
Keyswitch Arming	8	4	2	1		1506			8	4	2	1	8	4	2	1		1406			8	4	2	1
Auto-Bypass Re-entry	8	4	2	1		1507			8	4	2	1	8	4	2	1		1407			8	4	2	1
Pre-Alarm Warning	8	4	2	1		1508			8	4	2	1	8	4	2	1		1408			8	4	2	1
Never Arm	8	4	2	1		1509			8	4	2	1	8	4	2	1		1409			8	4	2	1
24-Hour Zone	8	4	2	1		1510			8	4	2	1	8	4	2	1		1410			8	4	2	1
✓ Burg. Alarm Output	8	4	2	1		1511			8	4	2	1	8	4	2	1		1411			8	4	2	1
✓ Pulsed Alarm Output	8	4	2	1		1512			8	4	2	1	8	4	2	1		1414			8	4	2	1
Fire Output (Lug E9)	8	4	2	1		1515			8	4	2	1	8	4	2	1		1413			8	4	2	1
Reset Relay	8	4	2	1		1514			8	4	2	1	8	4	2	1		1414			8	4	2	1
Auxiliary Relay	8	4	2	1		1515			8	4	2	1	8	4	2	1		1415			8	4	2	1
✓ Entry/Exit 1	8	4	2	1		1516			8	4	2	1	8	4	2	1		1416			8	4	2	1
Entry/Exit 2	8	4	2	1		1517			8	4	2	1	8	4	2	1		1417			8	4	2	1
Exit/Entry Follower	8	4	2	1		1518			8	4	2	1	8	4	2	1		1418			8	4	2	1
✓ Auto Reset	8	4	2	1		1519			8	4	2	1	8	4	2	1		1419			8	4	2	1
✓ Swinger Shutdown	8	4	2	1		1520			8	4	2	1	8	4	2	1		1420			8	4	2	1
✓ Chime	8	4	2	1		1521			8	4	2	1	8	4	2	1		1421			8	4	2	1
Abort Delay	8	4	2	1		1522			8	4	2	1	8	4	2	1		1422			8	4	2	1
Power-up Delay	8	4	2	1		1523			8	4	2	1	8	4	2	1		1423			8	4	2	1
Day Zone Open	8	4	2	1		1524			8	4	2	1	8	4	2	1		1424			8	4	2	1
Day Zone Short	8	4	2	1		1525			8	4	2	1	8	4	2	1		1425			8	4	2	1
Alarm on Day Zone	8	4	2	1		1526			8	4	2	1	8	4	2	1		1426			8	4	2	1
✓ Alarm Telco 1	8	4	2	1		1527			8	4	2	1	8	4	2	1		1427			8	4	2	1
Alarm Restore 1	8	4	2	1		1528			8	4	2	1	8	4	2	1		1428			8	4	2	1
Trouble Telco 1	8	4	2	1		1529			8	4	2	1	8	4	2	1		1429			8	4	2	1
Trouble Restore 1	8	4	2	1		1530			8	4	2	1	8	4	2	1		1430			8	4	2	1
Alarm Telco 3	8	4	2	1		1535			8	4	2	1	8	4	2	1		1435			8	4	2	1
Alarm Restore 3	8	4	2	1		1536			8	4	2	1	8	4	2	1		1436			8	4	2	1
Trouble Telco 3	8	4	2	1		1537			8	4	2	1	8	4	2	1		1437			8	4	2	1
Trouble Restore 3	8	4	2	1		1538			8	4	2	1	8	4	2	1		1438			8	4	2	1
No EOL Resistor	8	4	2	1		1539			8	4	2	1	8	4	2	1		1439			8	4	2	1
Sensor Watch	8	4	2	1		1540			8	4	2	1	8	4	2	1		1440			8	4	2	1
Trouble on Open	8	4	2	1		1541			8	4	2	1	8	4	2	1		1441			8	4	2	1
Trouble on Short	8	4	2	1		1542			8	4	2	1	8	4	2	1		1442			8	4	2	1
Trouble on Night Open	8	4	2	1		1543			8	4	2	1	8	4	2	1		1443			8	4	2	1
✓ Zone Area 1	8	4	2	1		1544			8	4	2	1	8	4	2	1		1444			8	4	2	1
✓ Zone Area 2	8	4	2	1		1545			8	4	2	1	8	4	2	1		1445			8	4	2	1
Zone ANDing Group 1	8	4	2	1		1554			8	4	2	1	8	4	2	1		1454			8	4	2	1
Zone ANDing Group 2	8	4	2	1		1555			8	4	2	1	8	4	2	1		1455			8	4	2	1
✓ Interior #1 Bypass	8	4	2	1		1562			8	4	2	1	8	4	2	1		1462			8	4	2	1
✓ Keypad Sounder on Alarm	8	4	2	1		1564			8	4	2	1	8	4	2	1		1464			8	4	2	1
✓ Fire (C)	8	4	2	1		1575			8	4	2	1	8	4	2	1		1475			8	4	2	1
✓ Fire Alarm Verification (C)	8	4	2	1		1576			8	4	2	1	8	4	2	1		1476			8	4	2	1
Chime 2	8	4	2	1		1586			8	4	2	1	8	4	2	1		1486			8	4	2	1

↑ 1

↑ 2

↑ 4

↑ 4

↑ 2

↑ 2





↑ 4

↑ 4

↑ 2

See Zone Options on Page 50.

ZONE OPTIONS / ZONES 33-48 (ADDRESS 1602-1786)

ZONE OPTIONS	ZONES 45-48 LEFT DATA VALUES (CIRCLE )				ADDRESS 1702-1786			ZONES 41-44 RIGHT DATA VALUES (CIRCLE )				ZONES 37-40 LEFT DATA VALUES (CIRCLE )				ADDRESS 1602-1686			ZONES 33-36 RIGHT DATA VALUES (CIRCLE )			
	ZN48	ZN47	ZN46	ZN45	L	ADDR	R	ZN44	ZN43	ZN42	ZN41	ZN40	ZN39	ZN38	ZN37	L	ADDR	R	ZN36	ZN35	ZN34	ZN33
	✓ Priority	8	4	2	1		1702		8	4	2	1	8	4	2	1		1602		8	4	2
Priority with Bypass	8	4	2	1		1703		8	4	2	1	8	4	2	1		1603		8	4	2	1
Auto-Bypass	8	4	2	1		1704		8	4	2	1	8	4	2	1		1604		8	4	2	1
✓ Selective Bypass	8	4	2	1		1705		8	4	2	1	8	4	2	1		1605		8	4	2	1
Keyswitch Arming	8	4	2	1		1706		8	4	2	1	8	4	2	1		1606		8	4	2	1
Auto-Bypass Re-entry	8	4	2	1		1707		8	4	2	1	8	4	2	1		1607		8	4	2	1
Pre-Alarm Warning	8	4	2	1		1708		8	4	2	1	8	4	2	1		1608		8	4	2	1
Never Arm	8	4	2	1		1709		8	4	2	1	8	4	2	1		1609		8	4	2	1
24-Hour Zone	8	4	2	1		1710		8	4	2	1	8	4	2	1		1610		8	4	2	1
✓ Burg. Alarm Output	8	4	2	1		1711		8	4	2	1	8	4	2	1		1611		8	4	2	1
✓ Pulsed Alarm Output	8	4	2	1		1712		8	4	2	1	8	4	2	1		1616		8	4	2	1
Fire Output (Lug E9)	8	4	2	1		1717		8	4	2	1	8	4	2	1		1613		8	4	2	1
Reset Relay	8	4	2	1		1714		8	4	2	1	8	4	2	1		1616		8	4	2	1
Auxiliary Relay	8	4	2	1		1717		8	4	2	1	8	4	2	1		1615		8	4	2	1
✓ Entry/Exit 1	8	4	2	1		1716		8	4	2	1	8	4	2	1		1616		8	4	2	1
Entry/Exit 2	8	4	2	1		1717		8	4	2	1	8	4	2	1		1617		8	4	2	1
Exit/Entry Follower	8	4	2	1		1718		8	4	2	1	8	4	2	1		1618		8	4	2	1
✓ Auto Reset	8	4	2	1		1719		8	4	2	1	8	4	2	1		1619		8	4	2	1
✓ Swinger Shutdown	8	4	2	1		1720		8	4	2	1	8	4	2	1		1620		8	4	2	1
✓ Chime	8	4	2	1		1721		8	4	2	1	8	4	2	1		1621		8	4	2	1
Abort Delay	8	4	2	1		1722		8	4	2	1	8	4	2	1		1622		8	4	2	1
Power-up Delay	8	4	2	1		1723		8	4	2	1	8	4	2	1		1623		8	4	2	1
Day Zone Open	8	4	2	1		1724		8	4	2	1	8	4	2	1		1624		8	4	2	1
Day Zone Short	8	4	2	1		1725		8	4	2	1	8	4	2	1		1625		8	4	2	1
Alarm on Day Zone	8	4	2	1		1726		8	4	2	1	8	4	2	1		1626		8	4	2	1
✓ Alarm Telco 1	8	4	2	1		1727		8	4	2	1	8	4	2	1		1627		8	4	2	1
Alarm Restore 1	8	4	2	1		1728		8	4	2	1	8	4	2	1		1628		8	4	2	1
Trouble Telco 1	8	4	2	1		1729		8	4	2	1	8	4	2	1		1629		8	4	2	1
Trouble Restore 1	8	4	2	1		1730		8	4	2	1	8	4	2	1		1630		8	4	2	1
Alarm Telco 3	8	4	2	1		1735		8	4	2	1	8	4	2	1		1635		8	4	2	1
Alarm Restore 3	8	4	2	1		1736		8	4	2	1	8	4	2	1		1636		8	4	2	1
Trouble Telco 3	8	4	2	1		1737		8	4	2	1	8	4	2	1		1637		8	4	2	1
Trouble Restore 3	8	4	2	1		1738		8	4	2	1	8	4	2	1		1638		8	4	2	1
No EOL Resistor	8	4	2	1		1739		8	4	2	1	8	4	2	1		1639		8	4	2	1
Sensor Watch	8	4	2	1		1740		8	4	2	1	8	4	2	1		1640		8	4	2	1
Trouble on Open	8	4	2	1		1741		8	4	2	1	8	4	2	1		1641		8	4	2	1
Trouble on Short	8	4	2	1		1742		8	4	2	1	8	4	2	1		1642		8	4	2	1
Trouble on Night Open	8	4	2	1		1743		8	4	2	1	8	4	2	1		1643		8	4	2	1
✓ Zone Area 1	8	4	2	1		1744		8	4	2	1	8	4	2	1		1644		8	4	2	1
✓ Zone Area 2	8	4	2	1		1745		8	4	2	1	8	4	2	1		1645		8	4	2	1
Zone ANDing Group 1	8	4	2	1		1754		8	4	2	1	8	4	2	1		1654		8	4	2	1
Zone ANDing Group 2	8	4	2	1		1755		8	4	2	1	8	4	2	1		1655		8	4	2	1
✓ Interior #1 Bypass	8	4	2	1		1762		8	4	2	1	8	4	2	1		1662		8	4	2	1
Keypad Sounder on Alarm	8	4	2	1		1764		8	4	2	1	8	4	2	1		1664		8	4	2	1
✓ Fire (C)	8	4	2	1		1775		8	4	2	1	8	4	2	1		1675		8	4	2	1
✓ Fire Alarm Verification (C)	8	4	2	1		1776		8	4	2	1	8	4	2	1		1676		8	4	2	1
Chime 2	8	4	2	1		1786		8	4	2	1	8	4	2	1		1686		8	4	2	1

↑ 1

↑ 2

↑ 4

↑ 4

↑ 2

↑ 2

↑ 4

↑ 4

↑ 2

See Zone Options on Page 50.

Zone Options / Zones 33-48



ZONE OPTIONS / ZONES 1-48 (ADDRESS 1200-1786)

1. **Select** the desired zone option.

ZONE OPTIONS
50ms Loop Response ←
10ms Loop Response
Priority
Priority with Bypass
Auto-Bypass

2. **Enable** desired options for each zone by drawing a circle around its corresponding binary data value.

NOTE: No circle = feature disabled.

ZN04	ZN03	ZN02	ZN01
8	4	2	①

Draw Circle

3. **Search table** below for data entry.

DIGIT VALUE	DATA ENTRY	DIGIT VALUE	DATA ENTRY
8 4 2 1	Blank (-)	⑧ 4 2 1	8
8 4 2 ①	1	⑧ 4 2 ①	9
8 4 ② 1	2	⑧ 4 ② 1	0
8 4 ② ①	3	⑧ 4 ② ①	B
8 ④ 2 1	4	⑧ ④ 2 1	C
8 ④ 2 ①	5	⑧ ④ 2 ①	D
8 ④ ② 1	6	⑧ ④ ② 1	E
8 ④ ② ①	7	⑧ ④ ② ①	F

4. **Enter data** in address locations (left and right digits).

ADDRESS LOCATION		
L	ADDR	R
blank (-)	1200	1

NOTE: Dark shaded data value box shows option not available.

NOTE: See Direct Address Programming Example on page 19.



- NOTES:**
- (A) 50ms & 20 ms Loop Response only available for zones 1-8.
 - (B) 2-wire Smoke Detectors only available for zones 7 and 8.
 - (C) If Fire Alarm Verification is selected, then Fire must also be selected.



DEFAULTS: The zone options indicated are automatically set after exiting the Easy Menu Driven Mode.



- ✓ *Priority, Selective Bypass, Alarm Output, Auto Reset, Swinger Shutdown, Zone Area 1 and Zone Area 2* are enabled for the total number of zones entered in "AREA 1 # ZONES = 08" and "AREA 2 # ZONES = 00".
- ✓ *Alarm Telco 1* is enabled for all zones if [YES] is entered for "REPORT ALL ZONES TO CENTRAL ZONES? Y/N".
- ✓ *Entry/Exit 1 and Chime* are enabled for zone numbers entered in "EXIT / ENTRY ZONES".
- ✓ *Exit/Entry Follower and Interior Bypass* are enabled for zone numbers entered in "INTERIOR ZONES".
- ✓ *Fire, Pulse Alarm Output and Fire Verification* is enabled for the zone numbers entered in "FIRE ZONES".
- ✓ *2-Wire Smoke Detector* is enabled for zone numbers entered in "2 WIRE FIRE ZONES".



Note: See "Number of Zones & Keypads per Area" in Easy Menu Driven program Mode.



SYSTEM OPTIONS (ADDRESS 2415-2419)





SYSTEM OPTIONS	LEFT DATA VALUES (CIRCLE )	ADDRESS 2415	RIGHT DATA VALUES (CIRCLE )	SYSTEM OPTIONS				
RESERVED	1	<table border="1" style="margin: auto;"> <tr><td style="width: 50%;">LEFT DIGIT (SUM OF DATA VALUES)</td><td style="width: 50%;">RIGHT DIGIT (SUM OF DATA VALUES)</td></tr> <tr><td style="text-align: center;">blank (*)</td><td style="text-align: center;"> </td></tr> </table> <p>[Default = blank (*) blank (*)]</p>	LEFT DIGIT (SUM OF DATA VALUES)	RIGHT DIGIT (SUM OF DATA VALUES)	blank (*)		1	Disable Fire Reset (Area 1)
LEFT DIGIT (SUM OF DATA VALUES)	RIGHT DIGIT (SUM OF DATA VALUES)							
blank (*)								
RESERVED	2		2	Disable Fire Reset (Area 2)				
RESERVED	4	4	RESERVED					
RESERVED	8	8	RESERVED					

SYSTEM OPTIONS	LEFT DATA VALUES (CIRCLE )	ADDRESS 2416	RIGHT DATA VALUES (CIRCLE )	SYSTEM OPTIONS				
RESERVED	1	<table border="1" style="margin: auto;"> <tr><td style="width: 50%;">LEFT DIGIT (SUM OF DATA VALUES)</td><td style="width: 50%;">RIGHT DIGIT (SUM OF DATA VALUES)</td></tr> <tr><td style="text-align: center;">blank (*)</td><td style="text-align: center;"> </td></tr> </table> <p>[Default = blank (*) blank (*)]</p>	LEFT DIGIT (SUM OF DATA VALUES)	RIGHT DIGIT (SUM OF DATA VALUES)	blank (*)		1	Enable Day Zone Watch (Area 1)
LEFT DIGIT (SUM OF DATA VALUES)	RIGHT DIGIT (SUM OF DATA VALUES)							
blank (*)								
RESERVED	2		2	Enable Day Zone Watch (Area 2)				
RESERVED	4	4	RESERVED					
RESERVED	8	8	RESERVED					

SYSTEM OPTIONS	LEFT DATA VALUES (CIRCLE )	ADDRESS 2417	RIGHT DATA VALUES (CIRCLE )	SYSTEM OPTIONS				
RESERVED	1	<table border="1" style="margin: auto;"> <tr><td style="width: 50%;">LEFT DIGIT (SUM OF DATA VALUES)</td><td style="width: 50%;">RIGHT DIGIT (SUM OF DATA VALUES)</td></tr> <tr><td style="text-align: center;"> </td><td style="text-align: center;"> </td></tr> </table> <p>[Default = blank (*) blank (*)]</p>	LEFT DIGIT (SUM OF DATA VALUES)	RIGHT DIGIT (SUM OF DATA VALUES)			1	Opening Report only after Alarm Report
LEFT DIGIT (SUM OF DATA VALUES)	RIGHT DIGIT (SUM OF DATA VALUES)							
Answering Machine P/U W/O Line Seizure	2		2	Closing Report only on Cond. Closing (Auto-Byp.)				
Disable Auto-Unbypass on Disarming	4	4	Include Sel./Grp. Bypass in Cond. Closing Status					
Bypass Faulted Zones	8	8	Status Report (Auto-Byp. Zones on Clos.)					

SYSTEM OPTIONS	LEFT DATA VALUES (CIRCLE )	ADDRESS 2418	RIGHT DATA VALUES (CIRCLE )	SYSTEM OPTIONS				
Access Control (Panel) on Aux. Output	1	<table border="1" style="margin: auto;"> <tr><td style="width: 50%;">LEFT DIGIT (SUM OF DATA VALUES)</td><td style="width: 50%;">RIGHT DIGIT (SUM OF DATA VALUES)</td></tr> <tr><td style="text-align: center;"> </td><td style="text-align: center;"> </td></tr> </table> <p>[Default = blank (*) blank (*)]</p>	LEFT DIGIT (SUM OF DATA VALUES)	RIGHT DIGIT (SUM OF DATA VALUES)			1	Auto Bell Test on Arming
LEFT DIGIT (SUM OF DATA VALUES)	RIGHT DIGIT (SUM OF DATA VALUES)							
Enable Burg. Output Warning on Entry	2		2	Auto Reset after Burg. Output Timeout				
Enable Manager's Mode	4	4	Suppress "Bypass" Reminder when Armed					
Start Exit Delay after Ringback	8	8	RESERVED					

SYSTEM OPTIONS	LEFT DATA VALUES (CIRCLE )	ADDRESS 2419	RIGHT DATA VALUES (CIRCLE )	SYSTEM OPTIONS				
Disable Function-Mode Download	1	<table border="1" style="margin: auto;"> <tr><td style="width: 50%;">LEFT DIGIT (SUM OF DATA VALUES)</td><td style="width: 50%;">RIGHT DIGIT (SUM OF DATA VALUES)</td></tr> <tr><td style="text-align: center;"> </td><td style="text-align: center;"> </td></tr> </table> <p>[Default = blank (*) blank (*)]</p>	LEFT DIGIT (SUM OF DATA VALUES)	RIGHT DIGIT (SUM OF DATA VALUES)			1	Interior 1 Normally Bypassed
LEFT DIGIT (SUM OF DATA VALUES)	RIGHT DIGIT (SUM OF DATA VALUES)							
Disable Callback Download	2		2	Enable Exit-Delay Restart				
Disable Answering-Machine Download	4	4	Reset Day Zone with Arm/Disarm Only					
Disable Auto-Reset on Day Zone	8	8	Enable Local Alarm on First Zone "AND" Trip					

-  1. Select the desired option by circling  the data values for each digit (left and right).
 -  2. Add the data values (ex: 15=1+2+4+8) from the selected options.
 -  3. Enter in address location (left and right digits).
- NOTE:** Dark shaded data value box shows option not available.

SYSTEM OPTIONS (ADDRESS 2420-2422, 3874 & 3879-3881)

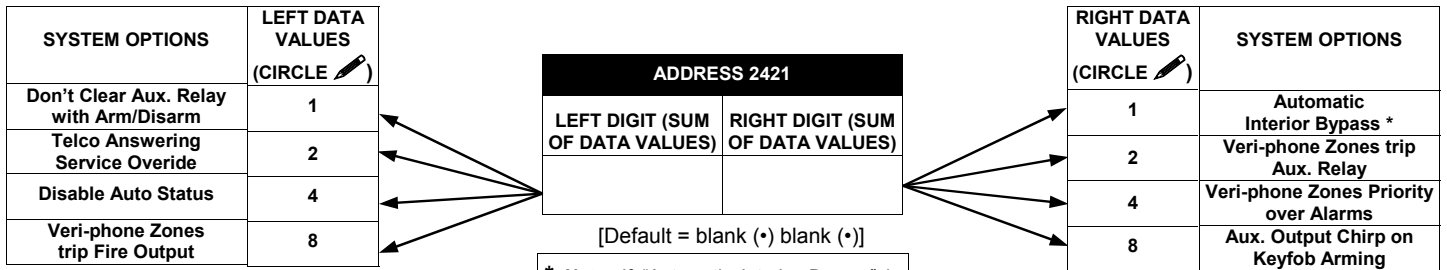
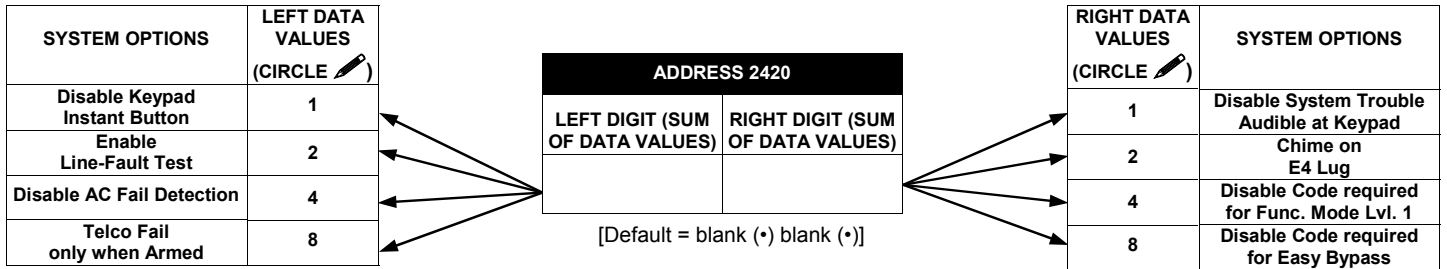

* Note: If "Automatic Interior Bypass" in Address 2421 is selected, then "Interior 1 Normally Bypassed" in Address 2419 must also be selected.

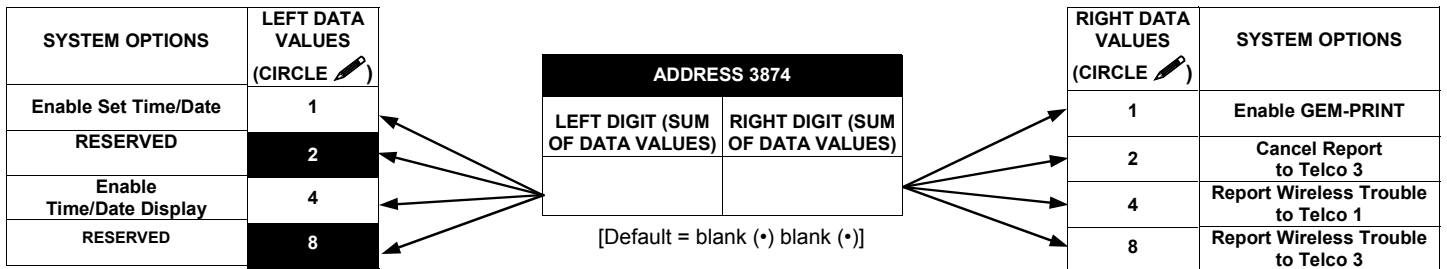
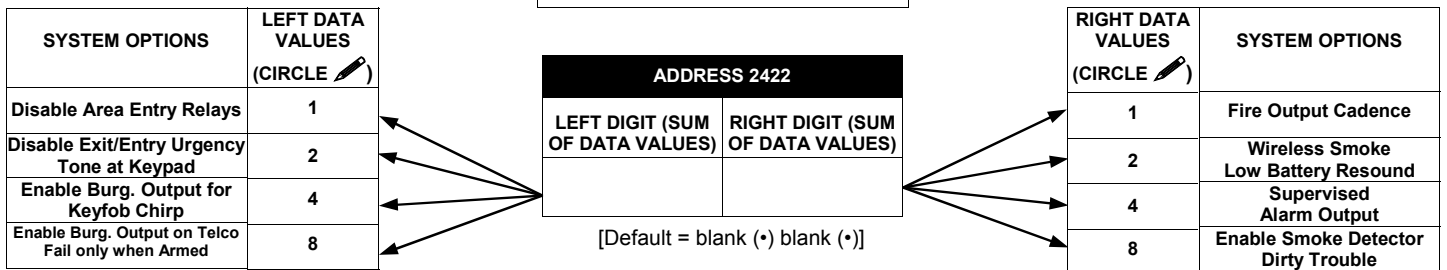

1. Select the desired option by circling the data values for each digit (left and right).
 2. Add the data values (ex: 15=1+2+4+8) from the selected options.
 3. Enter in address location (left and right digits).
- NOTE:** Dark shaded data value box shows option not available.

ALARM/TROUBLE REPORTING CODES	ADDRESS 3879-3881		
	LEFT	ADDR	RIGHT
Wireless Low Battery	blank (•)	3879	
Wireless Supervisory	blank (•)	3880	
Wireless Tamper	blank (•)	3881	

[Default = blank (•) blank (•) from address 3879-3881]

SYSTEM OPTIONS (ADDRESS 3882-3901, 3903-3905 & 4084)

Telephone Number Dialing Prefix (Digits 1-20)	ADDRESS 3882-3901 (RIGHT DIGITS 1-20)																				
	3882	3883	3884	3885	3886	3887	3888	3889	3890	3891	3892	3893	3894	3895	3896	3897	3898	3899	3900	3901	
	R	R	R	R	R	R	R	R	R	R	R	R	R	R	R	R	R	R	R	R	R

Pager Format: Re-sends of First Report	ADDRESS 3903	
	LEFT	RIGHT

[Default = blank (•) blank (•)]

Pager Format: Maximum Pages per Session	ADDRESS 3904	
	LEFT	RIGHT

[Default = blank (•) blank (•)]

Note: Left digit is RESERVED (not used). Enter data in right digit only.

ADDRESS 3905	
LEFT DIGIT (SUM OF DATA VALUES)	RIGHT DIGIT (SUM OF DATA VALUES)
blank (•)	

[Default = blank (•) blank (•)]

RIGHT DATA VALUES (CIRCLE )	SYSTEM OPTIONS
1	Disable System Trouble Audible Timeout
2	RESERVED
4	RESERVED
8	RESERVED

SYSTEM OPTIONS	LEFT DATA VALUES (CIRCLE )
RESERVED	1
RESERVED	2
RESERVED	4
Disable Auto Dial Tone Detection	8

ADDRESS 4084	
LEFT DIGIT (SUM OF DATA VALUES)	RIGHT DIGIT (SUM OF DATA VALUES)
	blank (•)

[Default = blank (•) blank (•)]

Note: Right digit is RESERVED (not used). Enter data in left digit only.

System Options



KEYPAD OPTIONS (ADDRESS 2425-2446)

Keypad 1 Type & Area Assignment	ADDRESS 2425	
	LEFT	RIGHT

[Default = blank (*) 1]

Keypad 2 Type & Area Assignment	ADDRESS 2426	
	LEFT	RIGHT

[Default = blank (*) blank (*)]

Keypad 3 Type & Area Assignment	ADDRESS 2427	
	LEFT	RIGHT

[Default = blank (*) blank (*)]

Keypad 4 Type & Area Assignment	ADDRESS 2428	
	LEFT	RIGHT

[Default = blank (*) blank (*)]

Keypad 5 Type & Area Assignment	ADDRESS 2429	
	LEFT	RIGHT

[Default = blank (*) blank (*)]

Keypad 6 Type & Area Assignment	ADDRESS 2430	
	LEFT	RIGHT

[Default = blank (*) blank (*)]

Keypad 7 Type & Area Assignment	ADDRESS 2431	
	LEFT	RIGHT

[Default = blank (*) blank (*)]

KEYPAD TYPE & AREA ASSIGNMENT: Up to 7 keypads may be programmed, if they are connected.

NOTE: See Keypad Configuration Mode. By default from the factory, each keypad is configured as number 1.

1. Select keypad type & area assignment for each keypad from the tables shown.
2. Enter in corresponding right and left digit address locations above.

KEYPAD TYPE	
LEFT	OPTION
blank (*)	Burg Keypad
2	Wizard Keypad

KEYPAD AREA ASSIGNMENT	
RIGHT	OPTION
blank (*)	Not Used
1	Area 1
2	Area 2

Keypad Options

KEYPAD NO.	KEYPAD OPTIONS				ADDRESS 2440-2446			KEYPAD OPTIONS			
	LEFT DATA VALUES (CIRCLE)				LEFT	ADDR	RIGHT	RIGHT DATA VALUES (CIRCLE)			
	TOUR STATION	PANEL ACCESS	EASY ARMING	AMBUSH				Rem. Acc. Only *	KEYPAD PANIC	KEYPAD AUXILIARY	KEYPAD FIRE
1	8	4	2	1	2440		8	4	2	1	
2	8	4	2	1	2441		8	4	2	1	
3	8	4	2	1	2442		8	4	2	1	
4	8	4	2	1	2443		8	4	2	1	
5	8	4	2	1	2444		8	4	2	1	
6	8	4	2	1	2445		8	4	2	1	
7	8	4	2	1	2446		8	④	②	①	

[Default = blank (*) and (7) for address 2440]

KEYPAD OPTIONS: Select options for any of the 7 keypads.

* **Note:** For Remote Access Control only (no Arm/Disarm capability).

1. Select the desired option by circling the data values for each digit (left and right).
2. Add the data values (ex: 15=1+2+4+8) from the selected options.
3. Enter in address location (left and right digits). **NOTE:** Dark shaded data value box shows option not available.

USER AREA OPTIONS (ADDRESS 2500-2547)

USER NO.	ADDRESS 2500-2547			AREAS 1-4 RIGHT DATA VALUES (CIRCLE )			
	L	ADDR	R	A4	A3	A2	A1
1	(•)	2500		8	4	2	1
2	(•)	2501		8	4	2	1
3	(•)	2502		8	4	2	1
4	(•)	2503		8	4	2	1
5	(•)	2504		8	4	2	1
6	(•)	2505		8	4	2	1
7	(•)	2506		8	4	2	1
8	(•)	2507		8	4	2	1
9	(•)	2508		8	4	2	1
10	(•)	2509		8	4	2	1
11	(•)	2510		8	4	2	1
12	(•)	2511		8	4	2	1
13	(•)	2512		8	4	2	1
14	(•)	2513		8	4	2	1
15	(•)	2514		8	4	2	1
16	(•)	2515		8	4	2	1
17	(•)	2516		8	4	2	1
18	(•)	2517		8	4	2	1
19	(•)	2518		8	4	2	1
20	(•)	2519		8	4	2	1
21	(•)	2520		8	4	2	1
22	(•)	2521		8	4	2	1
23	(•)	2522		8	4	2	1
24	(•)	2523		8	4	2	1
25	(•)	2524		8	4	2	1
26	(•)	2525		8	4	2	1
27	(•)	2526		8	4	2	1
28	(•)	2527		8	4	2	1
29	(•)	2528		8	4	2	1
30	(•)	2529		8	4	2	1
31	(•)	2530		8	4	2	1
32	(•)	2531		8	4	2	1
33	(•)	2532		8	4	2	1
34	(•)	2533		8	4	2	1
35	(•)	2534		8	4	2	1
36	(•)	2535		8	4	2	1
37	(•)	2536		8	4	2	1
38	(•)	2537		8	4	2	1
39	(•)	2538		8	4	2	1
40	(•)	2539		8	4	2	1
41	(•)	2540		8	4	2	1
42	(•)	2541		8	4	2	1
43	(•)	2542		8	4	2	1
44	(•)	2543		8	4	2	1
45	(•)	2544		8	4	2	1
46	(•)	2545		8	4	2	1
47	(•)	2546		8	4	2	1
48	(•)	2547		8	4	2	1





[Default = blank (•) blank (•) from address 2500-2547]

User Area Options

 1. **Select** the desired user number.

USER NO.
1
2
3
4
5

 2. **Enable** desired areas for each user by drawing a circle  around its corresponding binary data value.

NOTE: No circle = feature disabled.

A4	A3	A2	A1
8	4	2	①

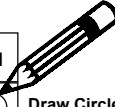
 Draw Circle

 3. **Search table** below for data entry.

DIGIT VALUE	DATA ENTRY	DIGIT VALUE	DATA ENTRY
8 4 2 1	Blank (•)	⑧ ④ ② ①	8
8 4 2 ①	1	⑧ ④ 2 ①	9
8 4 ② 1	2	⑧ ④ ② 1	0
8 4 ② ①	3	⑧ ④ ② ①	B
8 ④ 2 1	4	⑧ ④ 2 1	C
8 ④ 2 ①	5	⑧ ④ 2 ①	D
8 ④ ② 1	6	⑧ ④ ② 1	E
8 ④ ② ①	7	⑧ ④ ② ①	F

 4. **Enter data** in address locations (left and right digits).

ADDRESS LOCATION		
L	ADDR	R
blank (•)	2500	1

EZM GROUP OPTIONS (ADDRESS 2600-2627)

EZM Group 1		EZM Group 2		EZM Group 3		EZM Group 4		EZM Group 5		EZM Group 6	
ZONES 9-12		ZONES 13-16		ZONES 17-20		ZONES 21-24		ZONES 25-28		ZONES 29-32	
ADDRESS 2600		ADDRESS 2601		ADDRESS 2602		ADDRESS 2603		ADDRESS 2604		ADDRESS 2605	
LEFT	RIGHT	LEFT	RIGHT	LEFT	RIGHT	LEFT	RIGHT	LEFT	RIGHT	LEFT	RIGHT
blank (•)		blank (•)		blank (•)		blank (•)		blank (•)		blank (•)	

Default depends on Easy Menu Question “# OF ZNS IN AREA1” and “# OF ZNS IN AREA1”.
 For example, if 32 zones are used, then all 6 groups will be automatically enabled.
 If only 8 zones are used, then groups 1-6 will be automatically disabled.

NOTE: Zones 1-8 are included in the control panel and Zones 9-32 (Groups 1-6) are EZM Zones (either Wireless or Hardwired).
 Zones 33-48 must be wireless zones only (No EZM groups can be assigned to these zones).

EZM TYPE	
DATA ENTRIES	OPTION
RIGHT	
blank (•)	Not used (No EZM present)
1	4-Zone EZM

EZM GROUP OPTIONS: Up to 6 Groups of 4 Zones each may be programmed depending on the number of zones used and which EZM modules are connected. Each group represents 4 zones.

1. Select EZM type from the table shown.
 2. Enter in corresponding address locations above (right digit only).
- NOTE:** Dark shaded data value box shows option not available.

EZM PGM TERMINAL CONTROL												
GROUP NO.	LEFT DATA VALUES (CIRCLE)					ADDRESS 2622-2632			AREAS 1-2 RIGHT DATA VALUES (CIRCLE)			
						L	ADDR	R			A2	A1
1	8	4	2	1	(•)	2622			8	4	2	1
2	8	4	2	1	(•)	2623			8	4	2	1
3	8	4	2	1	(•)	2624			8	4	2	1
4	8	4	2	1	(•)	2625			8	4	2	1
5	8	4	2	1	(•)	2626			8	4	2	1
6	8	4	2	1	(•)	2627			8	4	2	1

[Default = blank (•) blank (•) from address 2622-2627]

EZM PGM ARMED TERMINAL CONTROL: For each zone group select the area(s) which, when armed, will activate the PGM Lug on the corresponding EZM modules. Each zone group corresponds to 4 zones. If 8-Zone EZMs are used each one is treated as TWO zone groups. **NOTE:** Lug goes ACTIVE (low) when ANY selected area is armed. When activated, the PGM Lug goes negative (to Ground).





1. Select the desired group number.
2. Enable desired options for each area by drawing a circle around its corresponding binary data value.
NOTE: No circle = feature disabled.
3. Enter data in corresponding left and right digit address locations above.

AREA ARMING OPTIONS (ADDRESS 2650-2651)

PRIORITY AREA ARMING							
ARMING AREA	ADDRESS 2650-2651			AREAS 1-2 RIGHT DATA VALUES (CIRCLE )			
	L	ADDR	R			A2	A1
	AREA 1	(•)	2650		8	4	2
AREA 2	(•)	2651		8	4	2	1

[Default = blank (•) blank (•) from address 2650-2657]



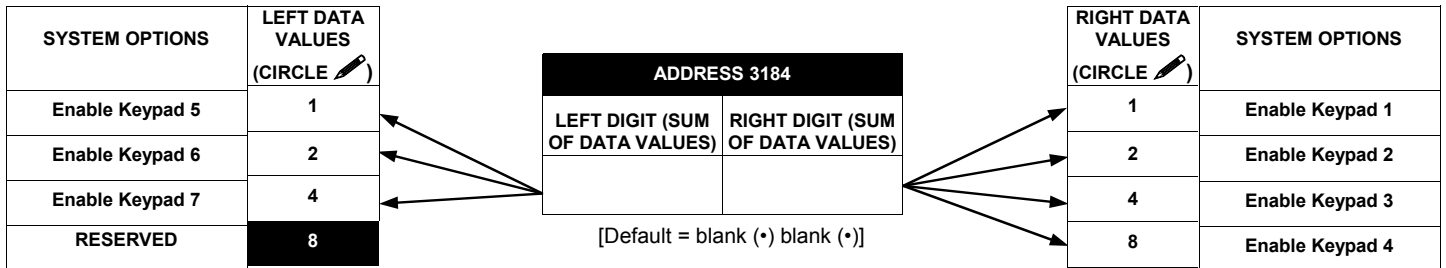

PRIORITY AREA ARMING:

-  1. Select the desired arming area.
-  2. Enable desired options for each priority area by drawing a circle  around its corresponding binary data value.
NOTE: No circle = feature disabled.
-  3. Enter data in corresponding left and right digit address locations above.
NOTE: Dark shaded data value box shows option not available.

REMOTE ACCESS LOGGING (ADDRESS 3184)



REMOTE ACCESS LOGGING: Enable logging of every keypad access event.

-  1. Select the desired option by circling  the data values for each digit (left and right).
-  2. Add the data values (ex: 15=1+2+4+8) from the selected options.
-  3. Enter in address location (left and right digits).
NOTE: Dark shaded data value box shows option not available.

AREA OUTPUT CONTROL OPTIONS (ADDRESS 2700-2733)

OUTPUT SILENCED (TURNED OFF)	DISARMING AREA 1 TURNS OFF AREA OUTPUT										DISARMING AREA 2 TURNS OFF AREA OUTPUT											
	LEFT DATA VALUES (CIRCLE)				ADDRESS 2700-2732			AREAS 1-2 RIGHT DATA VALUES (CIRCLE)			LEFT DATA VALUES (CIRCLE)				ADDRESS 2701-2733			AREAS 1-2 RIGHT DATA VALUES (CIRCLE)				
					L	ADDR	R			A2	A1					L	ADDR	R			A2	A1
Burglary Output	8	4	2	1	(*)	2700		8	4	2	①	8	4	2	1	(*)	2701		8	4	2	1
Pulsed Burg. Output	8	4	2	1	(*)	2708		8	4	2	①	8	4	2	1	(*)	2709		8	4	2	1
Fire Output	8	4	2	1	(*)	2716		8	4	2	1	8	4	2	1	(*)	2717		8	4	2	1
Reset Relay	8	4	2	1	(*)	2724		8	4	2	1	8	4	2	1	(*)	2725		8	4	2	1
Auxiliary Relay	8	4	2	1	(*)	2732		8	4	2	1	8	4	2	1	(*)	2733		8	4	2	1

[Default = 2700 (*) 2708 (*)]

AREA OUTPUT TURNS OFF UPON DISARM: Select options for any of the 5 Outputs per area when disarming a particular area.

1. Select the desired option by circling the data values for left and right digits.
2. Add the data values (ex: 15=1+2+4+8) from the selected options.
3. Enter in right digit address location. **NOTE:** Dark shaded data value box shows option not available.

RF RECEIVERS & SUPERVISORY TIMER OPTIONS (ADDRESS 3776 & 3760-3775)

Number of RF Receivers	ADDRESS 3776		DATA ENTRIES	RF Receiver(s)
	LEFT	RIGHT		
		blank (*)		RIGHT
			blank (*)	None
			1	1
			2	2

Default for Number of Receivers depends on Easy Menu Question for RF Transmitters.

RF RECEIVERS: Up to 2 RF Receivers may be programmed.
NOTE: This adds wireless capability to the system, increasing up to 48 the number of zones.

1. Select the number of receivers from the table shown.
2. Enter in corresponding right digit address location shown (left digit is not used).

RF SUPERVISORY TIMER	RF TRANSMITTER	ADDRESS 3760-3767		
		LEFT	ADDR	RIGHT
Type 0	Window/Door, 2 Pt.		3760	
Type 1	Window/Door, 2 Pt.		3761	
Type 2	Window/Door, 2 Pt.		3762	
Type 3	Window/Door, 2 Pt.		3763	
Type 4	Window/Door, 4 Pt.		3764	
Type 5	PIR		3765	
Type 6	PIR		3766	
Type 7	Smoke Detector		3767	

[Default = blank (*) blank (*) from address 3760-3767]

RF SUPERVISORY TIMER	RF TRANSMITTER	ADDRESS 3768-3775		
		LEFT	ADDR	RIGHT
Type 8	Smoke Detector		3768	
Type 9	Keyfob		3769	
Type A	Dual Tech.		3770	
Type B	Keyfob		3771	
Type C	Window/Door, 4 Pt.		3772	
Type D	PIR		3773	
Type E	Smoke Detector		3774	
Type F	Napco Glass Break		3775	

[Default = blank (*) blank (*) from address 3768-3775]

RF SUPERVISORY TIMERS		
DATA ENTRIES		DELAY
LEFT	RIGHT	
blank (*)	blank (*)	0 min.
blank (*)	1	30 min.
blank (*)	2	60 min.
blank (*)	3	90 min.
blank (*)	4	120 min.
blank (*)	5	150 min.
blank (*)	6	180 min.
blank (*)	7	210 min.
blank (*)	8	240 min.
blank (*)	9	270 min.
blank (*)	0	300 min.
blank (*)	B	330 min.
blank (*)	C	360 min.
blank (*)	D	390 min.
blank (*)	E	420 min.
blank (*)	F	450 min.
1	blank (*)	480 min.
1	1	510 min.
1	2	540 min.
1	3	570 min.
1	4	600 min.
1	5	630 min.
1	6	660 min.
1	7	690 min.
1	8	720 min.
1	9	750 min.
1	0	780 min.
1	B	810 min.
1	C	840 min.
1	D	870 min.
1	E	900 min.
1	F	930 min.
2	blank (*)	960 min.
2	1	990 min.
2	2	1020 min.
2	3	1050 min.
2	4	1080 min.
2	5	1110 min.

RF SUPERVISORY TIMERS		
DATA ENTRIES		DELAY
LEFT	RIGHT	
2	6	1140 min.
2	7	1170 min.
2	8	1200 min.
2	9	1230 min.
2	0	1260 min.
2	B	1290 min.
2	C	1320 min.
2	D	1350 min.
2	E	1380 min.
2	F	1410 min.
3	blank (*)	1440 min.
3	1	1470 min.
3	2	1500 min.
3	3	1530 min.
3	4	1560 min.
3	5	1590 min.
3	6	1620 min.
3	7	1650 min.
3	8	1680 min.
3	9	1710 min.
3	0	1740 min.
3	B	1770 min.
3	C	1800 min.
3	D	1830 min.
3	E	1860 min.
3	F	1890 min.
4	blank (*)	1920 min.
4	1	1950 min.
4	2	1980 min.
4	3	2010 min.
4	4	2040 min.
4	5	2070 min.
4	6	2100 min.
↓	↓	↓
F	F	7650 min. = 127 Hr., 30 min.

RF SUPERVISORY TIMERS: RF Supervisory Timers may be programmed for each type of transmitter used. A transmitter will send a transmission every time it is tripped, when there is NO activity, the transmitter sends a status transmission about once an hour. If the receiver does NOT receive ANY signal (a trip or a status) from a transmitter in the time specified for transmitter type, a system trouble "RF SUPERVISORY FAILURE" will be displayed at the keypad.

1. Select timer delay from the table shown. Timers are programmed in increments of 30 minutes each. Valid entries are 03-FF, 90 minutes-7650 min (127 hr,30 min).

WARNING: Timers have uncertainty of +/-30 minutes. Do not use entries 0-2 (shaded areas).

2. Enter in corresponding address locations above (left and right digits).
3. For a desired *timer not* listed do the following:
 - A. Choose a desired timer (intervals of 30), ex: 3000 min. (50 Hours)
 - B. Divide it by 30, ex: 3000/30 = 100
 - C. Divide it by 16

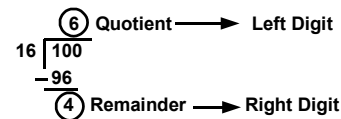

NOTE: These timers apply only to Supervised RF Transmitters (see RF Transmitters in Easy Menu Driven Mode Programming).

SYSTEM RESET OPTIONS (ADDRESS 4091-4093)

4091 XX

GEM-RP1CAe2 Keypad

Clear Dealer Program (Erases Dealer Program)



This erases the dealer program. Use this feature to start a customized default program.

4091XX

GEM-RP2ASe2 Keypad

Access address 4091, then press the  button. Data entry is not allowed.

NOTE: Enter Easy Menu Driven Program Mode to program system again.

4093 XX

GEM-RP1CAe2 Keypad

Cold Start (Erases Entire Program)



This erases the entire program (codes, schedules, foreign language configuration, etc), leaving the panel as it came right out of the box.

4093XX

GEM-RP2ASe2 Keypad

Access address 4093, then press the  button. Data entry is not allowed.

NOTE: Some features (schedules, language configuration) can only be re-programmed with the Downloading Software.

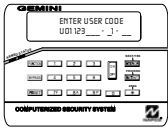

USER PROGRAM MODE

PRELIMINARY INFORMATION

The User Program Mode is covered in detail in the operating instructions for the keypad in use.

- ☞ Only Keypad #1 may be used for programming, however this keypad may be located in any area.
- ☞ The Program Mode cannot be accessed while the communicator is transmitting except during the first three minutes after power-up or while any area is armed.
- ☞ After entering codes or data, press the save button. Data will not be stored into memory unless this button is pressed.
- ☞ If the keypad is in the Program Mode and no activity is detected for longer than 4 minutes, a steady tone will sound. Press the button to silence the sounder and exit the User Program Mode.

NOTE: For ease of programming, it is recommended that a GEM-RP1CAe2 be used as Keypad #1. (A new GEM-RP1CAe2 is automatically configured as Keypad #1.)

If a GEM-RP2ASe2 is used, configure address jumpers as Keypad #1 (see the section of this manual Configuring the GEM-RP2ASe2 Keypad). Use the button to manually scroll the display at the end of each programming line.

ACCESSING USER PROGRAM MODE

1. Press

New Panel (Default User Code = 123)
Existing Panel (Any Code with User Program Option Enabled)
2. Press Until "ACTIVATE PROGRAM Y/N" (GEM-RP1CAe2) or "TURNON PROG Y/N" (GEM-RP2ASe2) appears on LCD screen.
3. Press To Enter User Program Mode
4. Press To Exit User Program Mode when finished

USER CODES

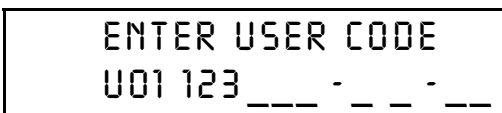

GEM-RP1CAe2 Keypad (Direct Entry)

Up to 48 User Codes may be programmed. **NOTE:** In this mode, only the code is programmable; the accompanying Area Options must be programmed in the Dealer Program Mode (see page 9).

- ☞ Use the button to place the cursor over the User Number.
- ☞ Enter a User Number (01-48) using the number buttons. The cursor will then advance to the User Code and read the existing code, if any.

User Code NOT USED

GEMINI

U01 123 - -

Enter user code

To Program User Codes

1. Set Cursor Position using the button.
2. Enter 2-digit User Number (01-96) directly using number buttons (0-9).
3. Enter Code (1-6 digits) directly using number buttons (0-9).
4. Press the button to save each code.

NOTE: Press button to clear character at cursor.
To continue press or .

Programming User Codes

User Program Mode: Accessing Program Mode

- ☞ Enter the new User Code using the number buttons (0-9). If an old code is displayed, program over it. To erase the digit at the cursor, press ***** **0** button.
- ☞ Press the **ON/OFF** button to save the code in memory.
- ☞ Repeat this procedure for each user. To proceed to Zone-Description programming, press the NEXT (**INTERIOR**) button.



GEM-PP2ASe2 Keypad



(Direct Entry)

To Program User Codes

1. Enter 2-digit User Number (01-96) directly using number buttons (0-9).
2. Press the **FUNCTION** button.
3. Enter Code (1-6 digits) directly using number buttons (0-9).
4. Press the **ON/OFF** button to save each code.

NOTE: Press ***** **0** button to clear character at cursor.
To continue press **INTERIOR** or **INSTANT** button.

Programming User Codes (GEM-PP2ASe2)

ZONE DESCRIPTIONS (GEM-PP1CAE2 KEYPADS ONLY)

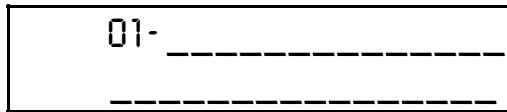

Enter an identifying description for each zone. Buttons **1** and **2** set the cursor position; buttons **3** and **6** scroll numbers, letters, punctuation marks, etc.

- ☞ Position the cursor over the displayed Zone Number (i.e., "01") using buttons **1** and **2**.
- ☞ Change the Zone Number using buttons **3** and **6**.
- ☞ Position the cursor over the first character of the description field. Advancing the cursor between characters, program a description of up to two lines for the new zone using buttons **3** and **6**.

- ☞ Press the **ON/OFF** button to save. Advance to the next zone as in Steps 1 and 2 above and repeat this procedure until all zones have been programmed.

To Program Zone Descriptions

1. Set the Cursor Position using buttons **1** and **2**.
2. Select characters for zone description using buttons **3** and **6**.
4. Press the **ON/OFF** button to save each descriptor.

NOTE: Press ***** **0** button to clear character at cursor.
To continue press **INTERIOR** or **INSTANT** button.

Programming Zone Descriptions

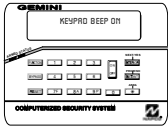

KEYPAD CONFIGURATION MODE

This section will focus on configuring the GEM-RP1CAe2 and GEM-RP2ASe2 Keypads. If there is more than one keypad in the system, *only Keypad No. 1 may be used for programming.*

KEYPAD INSTALLATION

Three types of keypads may be used with the GEM-P9600: the GEM-RP1CAe2, GEM-RP2ASe2 and the GEM-RP3DGTL. Each must be assigned an address number (1–7 and each requires its own configuration procedure (see CONFIGURING THE KEYPADS, which follows, and DIRECT ADDRESS KEYPAD AREA OPTIONS). At least 1 keypad must be used; only 1 is required for a single-area Commercial Burglary installation.

GEM-RP1CAe2 - is a 2-line combination fire/burglary/access keypad capable of supporting 4 EZM zones and a PGM output. A GEM-RP1CAe2 is recommended for use as Keypad #1.

GEM-RP2ASe2 - is a utility LCD keypad combining several preset LCD words with a limited message line. **NOTE:** Due to space constraints, available messages are abbreviated and will scroll automatically.

GEM-RP3DGTL - is a 2 digit LED display keypad for arming and disarming.

CONFIGURING THE KEYPADS

A total of up to 7 keypads may be connected to the panel. GEM-RP1CAe2 and GEM-RP2ASe2 keypads may be intermixed but require different configuration procedures, as described in the following paragraphs.

Configuring the GEM-RP1CAe2 Keypad

Each GEM-RP1CAe2 keypad must be configured for (a) keypad tactile beep; (b) entry sounder; (c) keypad address; (d) compatibility number; (e) EZM address; and (f) zone response.

To enter the GEM-RP1CAe2 Configuration Mode:

1. Move jumper JP5 (located at the upper-right corner of the control panel board) from Pins 1-2 (top two) to Pins 2-3 (bottom two). **NOTE:** See Wiring Diagram on page 75.
2. After about 15 seconds, the display will read "XX OUT OF SYSTEM", where XX indicates the keypad address.
3. Press and proceed as follows. (Repeat the following procedure for all keypads.)

NORMAL
KEYPAD
CONFIGURE

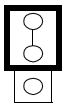

KEYPAD BEEP ON

Keypad Tactile Beep

Upon entering the Keypad Configuration Mode, "KEYPAD BEEP ON" will be displayed, indicating that the tactile beep, which sounds when any button is pressed, is on. To turn off the tactile beep, press the button (the button will toggle the tactile beep on and off).

Press the button to continue or press the button to exit.

Entry Sounder

ENTRY SOUNDER ON

To turn off the keypad sounder during entry time, press the button (the button will toggle the tactile beep on and off). Press the button to continue or press the button to exit.

Keypad Address

KEYPAD ADDRESS 01

If more than one keypad is installed, each must be assigned a unique keypad address (that is, no two keypads may be numbered alike):

- ☞ keypads must be numbered consecutively (missing numbers are not permitted)
- ☞ only Keypad No. 1 may be used for programming.



To assign the keypad number, proceed as follows:

1. Enter the assigned keypad number 01–15, then press the button to save. A valid number will be acknowledged by a short beep; an invalid number will be rejected by a long beep.
2. Press the button to continue or press the button to exit.

NEW COMPAT# 0000

Compatibility Number



The compatibility number is a 4-digit security code that, if programmed into both the control panel and each GEM-RP1CAe2 keypad, dedicates the keypad to only that panel. That is, (a) similar keypads not having the correct compatibility number will not operate in the system and (b) a

keypad may not be removed for use on a system with a different compatibility number. Press the  button to continue or press the  button to exit.

EZM ADDRESS 01

EZM Address

The keypad's internal EZM (Expansion Zone Module) may be utilized to provide four additional wired zones. Whether used alone or in conjunction with optional GEM-EZM series modules or other keypad EZMs, it must be assigned a unique address (or Group number, see Keypad Programming Workbook) similar to its keypad address. If no other EZMs are to be used,

designate the keypad as Group "01" at the "EZM ADDRESS 00" display. In multiple-EZM systems, enter an assigned group number "01" through "06". (Each EZM must have a unique assigned group number, starting with "01" and proceeding consecutively.) Press the  button. Press the  button to continue or press the  button to exit.

ZONE RESPONSE 00



Zone Response

The normal loop response of each keypad expansion zone is 750mS, however the response time of any zone can be reduced to 50mS as follows.

1. Of the following, circle the number(s) in parentheses associated with the zone(s) to be changed:
Zone 1=(1); Zone 2=(2); Zone 3=(4); Zone 4=(8)
2. Add up the circled numbers.
3. At the keypad, enter the sum as a two-digit number "01" through "15" on the display, then press the  button.

Example. Change Zones 2, 3 and 4 to 50mS response.

1. Circle numbers for Zones 2, 3 and 4: (2), (4) and (8).
2. Add up the circled numbers: $2 + 4 + 8 = 14$.
3. Enter "14" at the keypad, then press the  button.

Press the  button to continue or press the  button to exit the Keypad Configuration Mode (display will read "01 OUT OF SYSTEM"). Then replace Jumper JP5 across Pins 1-2 (top two).

Configuring the GEM-RP2ASe2 and GEM-RP3DGTL Keypad

Up to 7 GEM-RP2ASe2 and/or GEM-RP3DGTL keypads may be connected to the panel (Keypads 1–7). Each must be configured for a keypad address. In addition, the keypad may be configured to disable (a) touchpad backlight; (b) LCD backlight; and (c) entry sounder. Keypads are configured by the proper selection of jumpers. Refer to the label on the circuit board insulation paper for jumper locations and a summary of settings.

KEYPAD NUMBER	KEYPAD NUMBER			PARK
	1	2	3	
1	OFF or ON*	OFF	OFF	STORE SPARE JUMPER AT THIS POSITION
2	OFF	ON	OFF	
3	ON	ON	OFF	
4	OFF	OFF	OFF	
5	ON	OFF	ON	
6	OFF	ON	ON	
7	ON	ON	ON	

KEYPAD ADDRESS

If more than one keypad is installed:

 Each must be assigned a unique address (that is, no two keypads may be numbered alike).

 Keypads must be addressed consecutively (that is, missing numbers are not permitted).

 Only Keypad No. 1 may be used for programming. (However, for ease of programming, it is recommended that a GEM-RP1CAe2 be selected as Keypad #1.)

Assign the keypad address number by selecting Jumpers J1–3 in accordance with the table at left.

***Note:** (1) Keypads are factory supplied with no jumpers installed and as such are automatically configured as Keypad No. 1. (2) Only one keypad in the system may be configured as Keypad No. 1, otherwise none will function.

TOUCHPAD BACK LIGHT

Cut Jumper A to disable touch pad backlighting to conserve 11mA standby current.

LCD BACKLIGHT

Cut Jumper B to disable LCD backlighting.

DISABLE SOUNDER

Cut Jumper C to disable the sounder. (Do not disable in UL applications.)



NAPCO Security Systems, Inc.
 333 Bayview Avenue, Amityville, New York 11701
 For Sales and Repairs, call toll free: (800) 645-9445
 For direct line to Technical Service, call toll free: (800) 645-9440
 Internet: <http://www.napcosecurity.com>

KEYPAD PROGRAMMING MODES

Note:

- 1. Functions that are not active, not programmed and/or not applicable to user's authority level will be suppressed and will not display.
- 2. Due to space constraints, GEM-RP2ASe2 messages are abbreviated ^(D).
- 3. Many functions will not be displayed (such as: "DISPLAY ZN FAULTS"). It will require a faulted zone to display.

FUNCTION MODE

Press **FUNCTION** button

FUNCTION	LEVEL ^(A)
DISPLAY ZN FAULTS	1
DISPLAY ZN BYPASSED	1
DISPLAY ZN DIRECTORY	1
ACTIVE BELL TEST	1
DISPLAY PHONE #'S	1
DISPLAY SYS TRBL	1
DISPLAY FIRE ALARM	1
DISPLAY FIRE TRBL	1
DISPLAY OP/CL	3
ACTIVATE OVERVIEW	3 ^(B)
ACTIVATE CHIME	1
ACTIVATE WATCH	2
RESET SYSTEM TRBL	3
RESET SENSOR MSG	3
START EXIT TIME	1
FAULT FIND	(C)
ACTIVATE LOCATE	(C)
EZM ZONE FIND	(C)

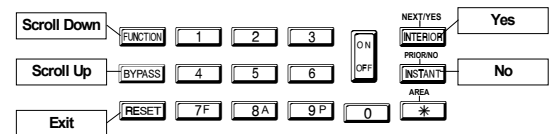

FUNCTION	LEVEL ^(A)
ACTIVATE DIALER TEST	3
DISPLAY ALARM LOG ^(D)	3
DISPLAY TOTAL LOG ^(D)	3
DISPLAY FIRE LOG ^(D)	3
DISPLAY OP/CL LOG ^(D)	3
DISPLAY SYSTEM LOG ^(D)	3
TO ARM IN 1-4HRS	2
DISPLAY AUTO ARM SCHED	3
ACTIVATE PROGRAM	3 ^(B)
ACTIVATE DOWNLOAD	3
DISPLAY RF XMITTER STAT	3
RELAY CONTROL	1

- (A) Minimum level required to access function
- (B) Level 3 code with appropriate option
- (C) Requires dealer code
- (D) Not available in GEM-RP2ASe2 / GEM-RP3DGTL keypads
- (E) Initial Configuration only; suppressed thereafter

Keypad Programming Modes: Function Mode

DEALER MODE

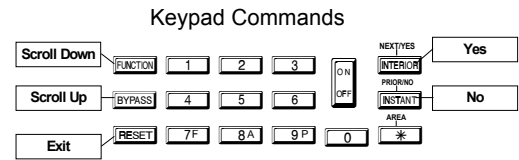
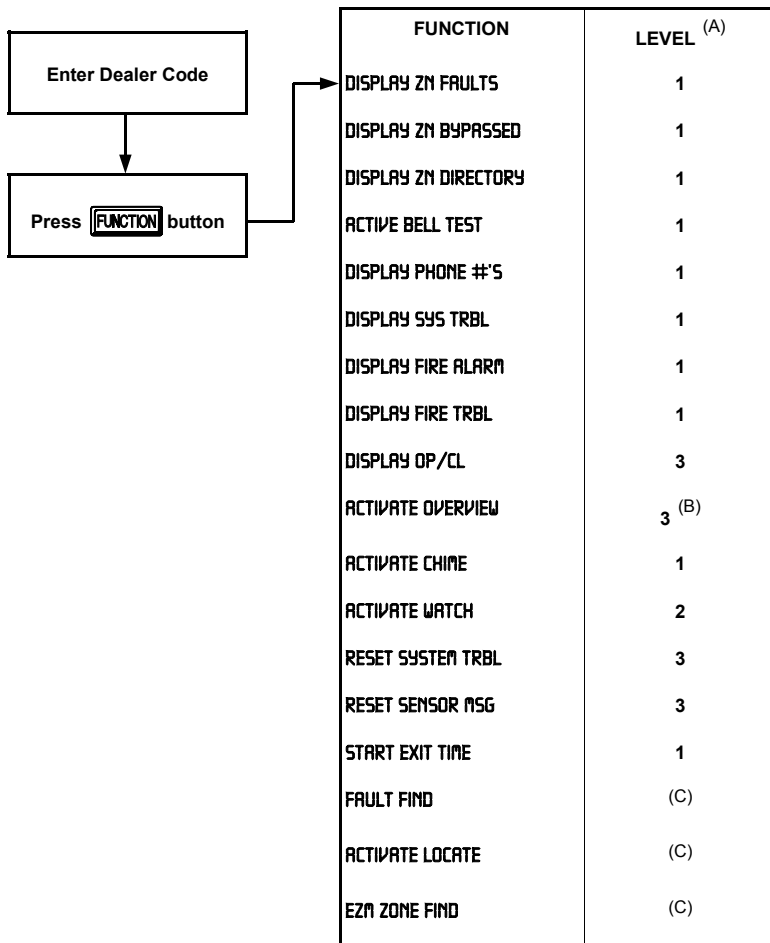

FUNCTION	LEVEL (A)
ACTIVATE DIALER TEST	3
DISPLAY ALARM LOG (D)	3
DISPLAY TOTAL LOG (D)	3
DISPLAY FIRE LOG (D)	3
DISPLAY OP/CL LOG (D)	3
DISPLAY SYSTEM LOG (D)	3
TO ARM IN 1-4HRS	2
DISPLAY AUTO ARM SCHED	3
ACTIVATE PROGRAM	3 (c)
ACTIVATE DOWNLOAD	3
DISPLAY RF XMITTER STAT	3
RELAY CONTROL	1

EASY MENU PROGRAM MODE

- (A) Minimum level required to access function
- (B) Level 3 code with appropriate option
- (C) Requires dealer code
- (D) Not available in GEM-RP2ASe2 / GEM-RP3DGTL keypads
- (E) Initial Configuration only; suppressed thereafter

EASY MENU MODE

Keypad Programming Modes: Easy Menu Mode

FUNCTION
AREA 1 # OF ZONES (E)
AREA 2 # OF ZONES (E)
FIRE ZONE NUMBERS (E)
2 WIRE FIRE ZONE NUMBERS (E)
REPORT ALL ZONES TO CENTRAL? Y/N (E)
EXIT/ENTRY ZONE NUMBERS (E)
INTERIOR ZONE NUMBERS (E)
AREA 1 # OF KEYPADS
AREA 2 # OF KEYPADS
CENTRAL PHONE NO.
ACCOUNT # (_ _ _)
RCVR FORMAT
ENTER USER CODE
ENTER ZONE DESCRIPTIONS
RF XMITTER ID CODE # + POINTS
KEY FOB ID CODE # + OPTIONS
ENTER DATE (MM/DD/YY)
ENTER TIME (HH:MM/P)
ENTER DEALER CODE

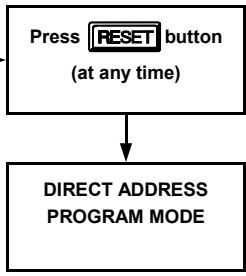
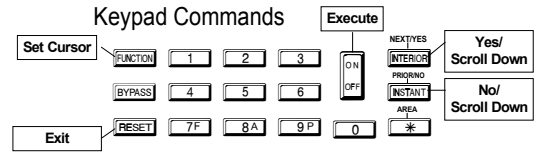

- (A) Minimum level required to access function
- (B) Level 3 code with appropriate option
- (C) Requires dealer code
- (D) Not available in GEM-RP2ASe2 / GEM-RP3DGTL keypads
- (E) Initial Configuration only; suppressed thereafter

USER MODE

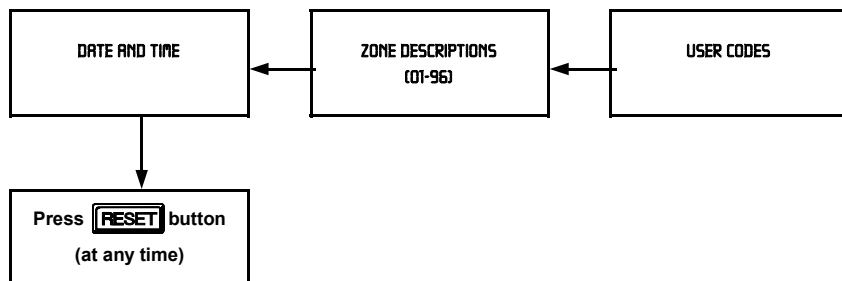
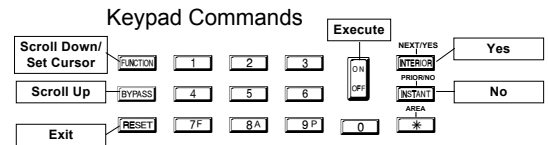
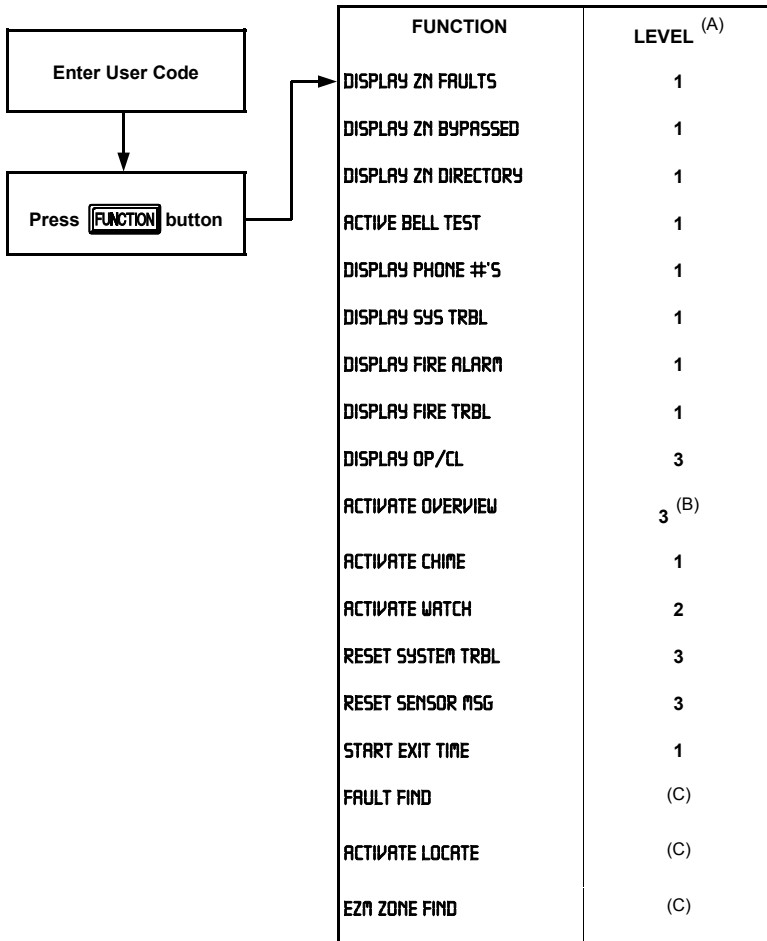

FUNCTION	LEVEL (A)
ACTIVATE DIALER TEST	3
DISPLAY ALARM LOG (D)	3
DISPLAY TOTAL LOG (D)	3
DISPLAY FIRE LOG (D)	3
DISPLAY OP/CL LOG (D)	3
DISPLAY SYSTEM LOG (D)	3
TO ARM IN 1-4HRS	2
DISPLAY AUTO ARM SCHD	3
ACTIVATE PROGRAM	3 (B)
ACTIVATE DOWNLOAD	3
DISPLAY RF XMITTER STAT	3
RELAY CONTROL	1

- (A) Minimum level required to access function
- (B) Level 3 code with appropriate option
- (C) Requires dealer code
- (D) Not available in GEM-RP2ASe2 / GEM-RP3DGTL keypads
- (E) Initial Configuration only; suppressed thereafter

KEYPAD CONFIGURATION MODE

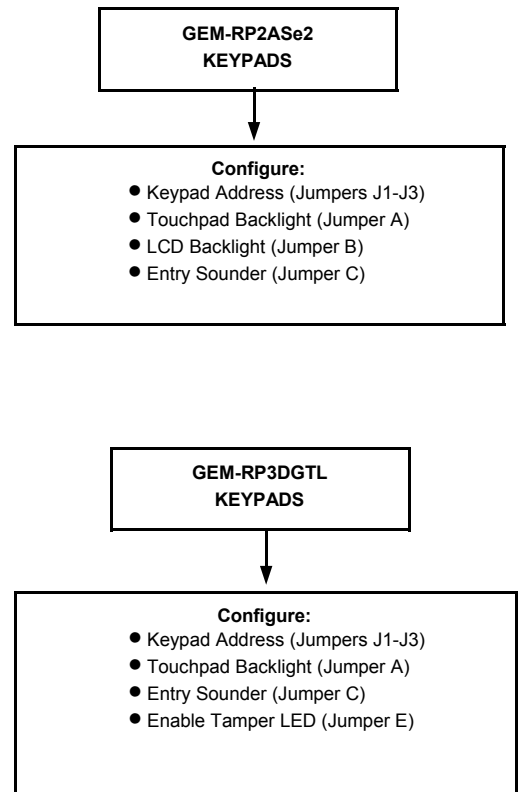
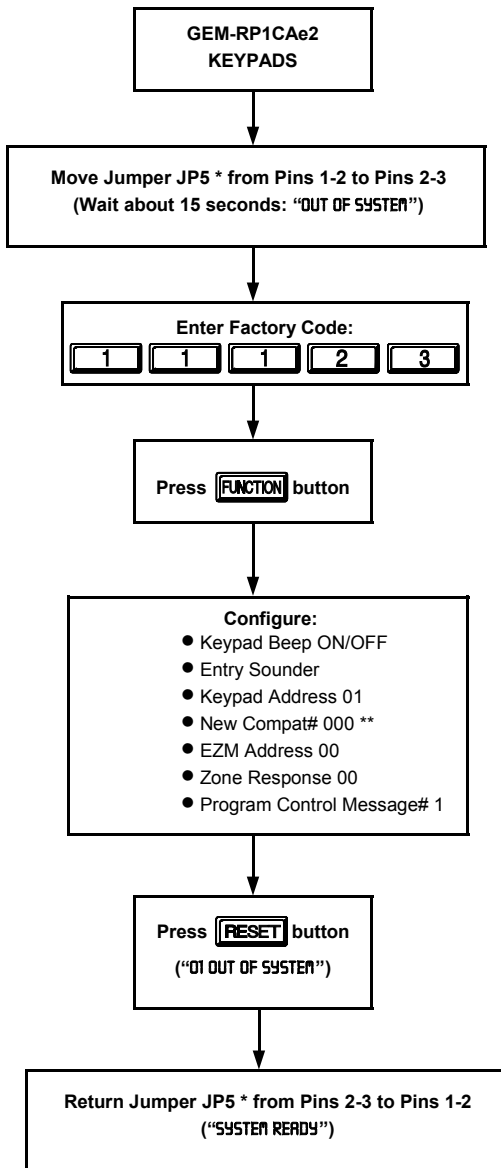

* JP5 is located at the top-right corner of the circuit board.

** If a Compatibility Number other than "0000" is programmed, "OLD COMPAT# XXXX" is displayed.

PROGRAMMING OPTIONS INDEX

PROGRAMMING OPTION	PROGRAM MODE	ADDRESS LOCATION	PAGE NUMBER
10ms Loop Response	Direct Address	1201	47 - 49
1400hz Handshake/Kissoff	Direct Address	0526,0551 & 0576	45
2300hz Handshake/Kissoff	Direct Address	0526,0551 & 0576	45
24-Hour Zone (Zone Option)	Direct Address	1210, 1310, 1410 & 1510	47 - 49
2-Wire Smoke Detectors (Zone Option)	Direct Address	1252	47
3/1 With Extended Restores	Direct Address	0526,0551 & 0576	45
50ms Loop Response	Direct Address	1200	47 - 49
Abort Delay per zone	Direct Address	1222, 1322, 1422 & 1522	47 - 49
Abort Delay Timeout	Direct Address	2406	35
AC Fail Report Delay	Direct Address	2408	35
Access Control (Panel) On Aux. Output	Direct Address	2418	51
Alarm On Day Zone	Direct Address	1226, 1326 1426 & 1526	47 - 49
Alarm Restore Report Code	Direct Address	0860	40
Alarm Restore 1 (Zone Option)	Direct Address	1228, 1328, 1428 & 1528	47 - 49
Alarm Restore 3 (Zone Option)	Direct Address	1236, 1336, 1436 & 1536	47 - 49
Alarm Supervisory Report Code	Direct Address	0871	41
Alarm Telco 1 (Zone Option)	Direct Address	1227, 1327, 1427 & 1527	47 - 49
Alarm Telco 3 (Zone Option)	Direct Address	1235, 1335, 1435 & 1535	47 - 49
Ambush Report Code	Direct Address	0900	41
Ambush (Keypad Option)	Direct Address	2440-2446	54
Ambush User Code	Direct Address	0495	36
Answering Machine P/U W/O Line Seizure	Direct Address	2417	51
Area Output Turns Off Upon Disarm	Direct Address	2700-2733	58
Area System Trouble Reporting Options	Direct Address	1120-1137	46
Auto Bell Test On Arming	Direct Address	2418	51
Auto Disarm Rearm Delay	Direct Address	4083	36
Auto Download Id No.	Direct Address	1023	38
Auto Reset (Zone Option)	Direct Address	1219, 1319, 1419 & 1519	47 - 49
Auto Reset After Burg. Output Timeout	Direct Address	2418	51
Auto-Bypass (Zone Option)	Direct Address	1204, 1304, 1404 & 1504	47 - 49
Auto-Bypass Re-Entry (Zone Option)	Direct Address	1207, 1307, 1407 & 1507	47 - 49
Automatic Interior Bypass	Direct Address	2421	52
Aux. Output Access Control Timeout	Direct Address	2402	35
Aux. Output Chirp On Keypad Arming	Direct Address	2421	52
Aux. Output Timeout	Direct Address	2401	36
Auxiliary KP Report Code	Direct Address	0903	41
Auxiliary Relay (Zone Option)	Direct Address	1215, 1315, 1415 & 1515	47 - 49
Backup Report On Telco 2	Direct Address	1027	41
Burg. Alarm Output (Zone Option)	Direct Address	1211, 1311, 1411 & 1511	47 - 49
Burg. Alarm Output Timeout	Direct Address	2403	36
Bus Failure Report Code	Direct Address	0872	41
Bypass Faulted Zones	Direct Address	2417	51
Callback Telephone No. Select	Direct Address	1022	38
Callback Telephone Number 1	Direct Address	0600-0619	38
Callback Telephone Number 2	Direct Address	0625-0644	38
Cancel Next Test Timer On Any Report	Direct Address	1027	41
Cancel Report Code	Direct Address	0859	40
Cancel Window Time	Direct Address	4082	36
Central Station Receiver 1 Account Number	Easy Menu Driven	N/A	7
Central Station Receiver 1 Format	Easy Menu Driven	N/A	8
Central Station Receiver 1 Telephone Number	Easy Menu Driven	N/A	7
Chime (Zone Option)	Direct Address	1221, 1321, 1421 & 1521	47 - 49
Chime On E4 Lug	Direct Address	2420	52
Chime Timeout	Direct Address	2407	35
Clear Dealer Program	Direct Address	4091	60
Closing Report Code	Direct Address	0864	40
Closing Report Only On Cond. Closing (Auto-Byp.)	Direct Address	2417	51
Cold Start	Direct Address	4093	60
Conditional Closing Report Code	Direct Address	0865	40
CS Receiver 1 Format	Direct Address	0525	37
CS Receiver 1 Options	Direct Address	0526	37
CS Receiver 1 Telephone Number	Direct Address	0527-0546	38
CS Receiver 2 Format	Direct Address	0550	37
CS Receiver 2 Options	Direct Address	0551	37
CS Receiver 2 Telephone Number	Direct Address	0552-0571	38



PROGRAMMING OPTION	PROGRAM MODE	ADDRESS LOCATION	PAGE NUMBER
CS Receiver 3 Format	Direct Address	0575	37
CS Receiver 3 Options	Direct Address	0576	37
CS Receiver 3 Telephone Number	Direct Address	0577-0596	38
CS System Report Options	Direct Address	1027	41
CS Telco 1 Subscriber Event Id Number	Direct Address	0682-0713	39
CS Telco 1 Subscriber Event Id Number (System)	Direct Address	0714-0717	39
CS Telco 1 Subscriber Opening/Closing Id Number)	Direct Address	0650-0681	39
CS Telco 2 Subscriber Event Id Number	Direct Address	0752-0783	39
CS Telco 2 Subscriber Event Id Number (System)	Direct Address	0784-0787	39
CS Telco 2 Subscriber Opening/Closing Id Number	Direct Address	0720-0751	39
CS Telco 3 Subscriber Event Id Number	Direct Address	0822-0853	40
CS Telco 3 Subscriber Event Id Number (System)	Direct Address	0854-0857	40
CS Telco 3 Subscriber Opening/Closing Id Number	Direct Address	0790-0821	40
CS User Reporting Codes	Direct Address	1030-1081	43
Day Zone Open (Zone Option)	Direct Address	1224, 1324, 1424 & 1524	47 - 49
Day Zone Short (Zone Option)	Direct Address	1225, 1325, 1425 & 1525	47 - 49
Dealer Security Code	Direct Address	0500-0502	36
Digital Dialer Test Report Code	Direct Address	0890	41
Disable Answering-Machine Download	Direct Address	2419	51
Disable Auto Dial Tone Detection	Direct Address	4084	53
Disable Auto Status	Direct Address	2421	52
Disable Auto-Reset On Day Zone	Direct Address	2419	51
Disable Auto-Unbypass On Disarming	Direct Address	2417	51
Disable Callback Download	Direct Address	2419	51
Disable Closing Reports Per Area	Direct Address	1025	41
Disable Code Required For Easy Bypass	Direct Address	2420	52
Disable Code Required For Func. Mode Lvl. 1	Direct Address	2420	52
Disable Exit/Entry Urgency Tone	Direct Address	2422	52
Disable Fire Reset (Area 1)	Direct Address	2415	51
Disable Fire Reset (Area 2)	Direct Address	2415	51
Disable Function-Mode Download	Direct Address	2419	51
Disable Keypad Instant Button	Direct Address	2420	52
Disable System Trouble Audible at Keypads	Direct Address	2420	52
Disable Opening Reports Per Area	Direct Address	1024	41
Disable Wait For Handshake	Direct Address	1027	41
Disable Wait For Silence	Direct Address	1027	41
Don't Clear Aux. Relay With Arm/Disarm	Direct Address	2421	52
Download Security Code	Direct Address	0645-0647	38
Easy Arming	Direct Address	2440-2454	54
Enable Output Chirp on Keyfob Arm/Disarm	Direct Address	2421	52
Enable Burg. Output for Keyfob Chirp	Direct Address	2422	52
Enable Burg. Output Warning on Entry	Direct Address	2418	51
Enable Burg. Output on Telco Fail only when Armed	Direct Address	2422	52
Enable Day Zone Watch (Area 1)	Direct Address	2416	51
Enable Day Zone Watch (Area 2)	Direct Address	2416	51
Enable Exit-Delay Restart	Direct Address	2419	51
Enable Line-Fault Test	Direct Address	2420	52
Enable Manager's Mode	Direct Address	2418	51
Enable Reporting To PC Preset	Direct Address	2417	51
Enable Smoke Detector Dirty Trouble	Direct Address	2422	52
Enable User Code By Area	Direct Address	2500-2547	55
Enable Zone Number On Pulse Alarm	Direct Address	0526, 0551 & 0576	37
Enter Date	Easy Menu Driven	N/A	12
Enter Time	Easy Menu Driven	N/A	13
Enter User Codes	Easy Menu Driven	N/A	9
Enter Zone Descriptions	Easy Menu Driven	N/A	12
Entry Delay 1	Direct Address	0001	35
Entry Delay 2	Direct Address	0002	35
Entry/Exit 1 (Zone Option)	Direct Address	1216, 1316, 1416 & 1516	47 - 49
Entry/Exit 2 (Zone Option)	Direct Address	1217, 1317, 1417 & 1517	47 - 49

PROGRAMMING OPTION	PROGRAM MODE	ADDRESS LOCATION	PAGE NUMBER
Exit Delay	Direct Address	0000	35
Exit/Entry Follower (Zone Option)	Direct Address	1218, 1318, 1418, . . . , 2318	47 - 49
EZM Group Options	Direct Address	2600-2605	56
EZM Pgm Armed Terminal Control	Direct Address	2622-2627	56
EZM Tamper Report Code	Direct Address	0876	41
Fail To Close Report Code	Direct Address	0868	40
Fail To Open Report Code	Direct Address	0869	40
Fire KP Reporting Code	Direct Address	0902	41
Fire (Zone Option)	Direct Address	1275, 1375, 1475, . . . , 2375	47 - 49
Fire Alarm Verification (Zone Option)	Direct Address	1276, 1376, 1476, . . . , 2376	47 - 49
Fire Output (Lug E9)	Direct Address	1213, 1313, 1413, . . . , 2313	47 - 49
Fire Output Cadence	Direct Address	2422	52
Fire Output Timeout	Direct Address	2405	36
Global System Trouble Reporting Options	Direct Address	1082-1116	45
Handshake For Local Telemetry	Direct Address	1027	41
Include Sel./Grp. Bypass In Cond. Closing Status	Direct Address	2417	51
Interior 1 Normally Bypassed	Direct Address	2419	51
Interior Bypass (Zone Option)	Direct Address	1262, 1362, 1462, . . . , 2362	47 - 49
Key Fob Transmitters	Easy Menu Driven	N/A	12
Keypad Area Assignment	Direct Address	2425-2439	54
Keypad Auxiliary	Direct Address	2440-2454	54
Keypad Fire	Direct Address	2440-2454	54
Keypad Options	Direct Address	2440-2454	54
Keypad Panic	Direct Address	2440-2454	54
Keypad Sounder On Alarm	Direct Address	1264, 1364, 1464, . . . , 2364	47 - 49
Keyswitch Arming	Direct Address	1206, 1306, 1406, . . . , 2306	47 - 49
Leading Digits For Pager Format (1st Digit)	Direct Address	0520	37
Leading Digits For Pager Format (2nd Digit)	Direct Address	0521	37
Local Or Central Station Reporting System	Easy Menu Driven	N/A	6
Memory Failure Report Code	Direct Address	0873	41
Never Arm (Zone Option)	Direct Address	1209, 1309, 1409, . . . , 2309	47 - 49
No EOL Resistor (Zone Option)	Direct Address	1239, 1339, 1439, . . . , 2339	47 - 49
No. Rings Before Pickup	Direct Address	4089	38
Number Of RF Receivers	Direct Address	3776	59
Number Of Zones & Keypads Per Area	Easy Menu Driven	N/A	6,7
Opening Report Code	Direct Address	0866	40
Opening After Alarm Reporting Code	Direct Address	0867	40
Opening Report Only After Alarm Report	Direct Address	2417	51
Panel AC Failure Report Code	Direct Address	0875	41
Panel Access	Direct Address	2440-2454	54
Panel Access Code	Direct Address	0490-0492	36
Panel Low Battery Report Code	Direct Address	0874	41
Panic KP Report Code	Direct Address	0901	41
Power-Up Delay (Zone Option)	Direct Address	1223, 1323, 1423, . . . , 2323	47 - 49
Pre-Alarm Warning (Zone Option)	Direct Address	1208, 1308, 1408, . . . , 2308	47 - 49
Priority (Zone Option)	Direct Address	1202, 1302, 1402, . . . , 2302	47 - 49
Priority Arming/Areas 1-2	Direct Address	2650-2651	57
Priority With Bypass (Zone Option)	Direct Address	1203, 1303, 1403, . . . , 2303	47 - 49
Program Change Report Code	Direct Address	0894	41
Pulse Alarm Output Timeout	Direct Address	2404	36
Pulsed Alarm Output (Zone Option)	Direct Address	1212, 1312, 1412, . . . , 2312	47 - 49
Rem. Acc. Only	Direct Address	2440-2454	54
Remote Access Logging	Direct Address	3184	57
Reset Day Zone With Arm/Disarm Only	Direct Address	2419	51
Reset Output Timeout	Direct Address	2400	36
Reset Relay (Zone Option)	Direct Address	1214, 1314, 1414, . . . , 2314	47 - 49
Resound On Wireless Smoke Low Battery	Direct Address	2419	51
RF Receiver Tamper Report Code (system)	Direct Address	0896	41
RF Receiver Trouble Report Code (system)	Direct Address	0895	41
RF Transmitter Low Battery Report Code (zone)	Direct Address	3879	52
RF Transmitter Supervisory Report Code (zone)	Direct Address	3880	52
RF Transmitter Tamper Report Code (zone)	Direct Address	3881	52
RF Supervisory Timers	Direct Address	3760-3775	59
RF Transmitter Points	Easy Menu Driven	N/A	11
RF Trouble Report Code	Direct Address	0897	41
Selective Bypass (Zone Option)	Direct Address	1205, 1305, 1405, . . . , 2305	47 - 49
Sensor Watch Report Code	Direct Address	0877	41



PROGRAMMING OPTION	PROGRAM MODE	ADDRESS LOCATION	PAGE NUMBER
Sensor Watch (Zone Option)	Direct Address	1240, 1340, 1440, . . . , 2340	47 - 49
Sensor Watch Delay	Direct Address	4088	35
Service Message Report Code	Direct Address	0893	41
Single Digit Only	Direct Address	0526,0551 & 0576	37
Start Exit Delay After Ringback	Direct Address	2418	51
Status Report (Auto-Byp. Zones On Clos.)	Direct Address	2417	51
Sum Check	Direct Address	0526,0551 & 0576	37
Supervised Alarm Output	Direct Address	2422	52
Suppress "Bypass" Reminder When Armed	Direct Address	2418	51
Swinger Shutdown (Zone Option)	Direct Address	1220, 1320, 1420, . . . , 2320	47 - 49
Tamper Report Code	Direct Address	0904	41
Telco Answering Service Override	Direct Address	2421	52
Telco Fail Only When Armed	Direct Address	2420	52
Telco Line Failure	Direct Address	0880	41
Telephone Dialing Prefix	Direct Address	3882 - 3901	53
Telephone Line Test Delay	Direct Address	2414	35
Test Timer Report Code	Direct Address	0870	41
Touchtone Dialing Only	Direct Address	1027	41
Touchtone Dialing W/Rotary Backup	Direct Address	1027	41
Transmit "402" Opening/Closing Code	Direct Address	1027	41
Trouble Report Code	Direct Address	0861	40
Trouble On Night Open	Direct Address	1243, 1343, 1443, . . . , 2343	47 - 49
Trouble On Open (Zone Option)	Direct Address	1241, 1341, 1441, . . . , 2341	47 - 49
Trouble On Short (Zone Option)	Direct Address	1242, 1342, 1442, . . . , 2342	47 - 49
Trouble Restore	Direct Address	0862	40
Trouble Restore 1 (Zone Option)	Direct Address	1230, 1330, 1430, . . . , 2330	47 - 49
Trouble Restore 3 (Zone Option)	Direct Address	1238, 1338, 1438, . . . , 2338	47 - 49
Trouble Telco 1 (Zone Option)	Direct Address	1229, 1329, 1429, . . . , 2329	47 - 49
Trouble Telco 3 (Zone Option)	Direct Address	1237, 1337, 1437, . . . , 2337	47 - 49
Veri-Phone Zones Priority Over Alarms	Direct Address	2421	52
Veri-Phone Zones Trip Aux. Relay	Direct Address	2421	52
Veri-Phone Zones Trip Fire Output	Direct Address	2421	52
Wireless Smoke Low Battery Resound	Direct Address	2422	52
Zone Anding Group 1 (Zone Option)	Direct Address	1254, 1354, 1454, . . . , 2354	47 - 49
Zone Anding Group 2 (Zone Option)	Direct Address	1255, 1355, 1455, . . . , 2355	47 - 49
Zone Area 1 (Zone Option)	Direct Address	1244, 1344, 1444, . . . , 2344	47 - 49
Zone Area 2 (Zone Option)	Direct Address	1245, 1345, 1445, . . . , 2345	47 - 49
Zone Options - Zones 1 To 96	Direct Address	1200-2376	47 - 49
Zones Report Code - Zones 1 to 96	Direct Address	0910-1005	42

GEM-P3200 WIRING DIAGRAM

GEM-P3200 Wiring Diagram

GEMINI GEM-P3200 WIRING DIAGRAM

(REFER TO OPERATION AND INSTALLATION INSTRUCTIONS WI817)

NAPCO SECURITY SYSTEMS, INC
AMITYVILLE, N.Y. 11701



This equipment should be installed in accordance with Chapter 2 of the National Fire Alarm Code, ANSI/NFPA 72-1996 (National Fire Protection Association Battery March Park, Quincy, MA 02269), and local codes. Information describing proper installation, operation, testing, maintenance, evacuation planning, and repair service is to be provided with this equipment. UL Listed Limited Energy Cable is required.

US
NORMAL
KEYPAD CONFIGURE

THIS UNIT INCLUDES AN ALARM VERIFICATION FEATURE THAT WILL RESULT IN A DELAY OF THE SYSTEM ALARM SIGNAL FROM THE INDICATED CIRCUITS. THE TOTAL DELAY (CONTROL UNIT PLUS SMOKE DETECTORS) SHALL NOT EXCEED 60 SECONDS. NO OTHER SMOKE DETECTORS SHALL BE CONNECTED TO THESE CIRCUITS UNLESS APPROVED BY THE LOCAL AUTHORITY HAVING JURISDICTION. CIRCUIT CONTROL UNIT SMOKE DETECTORS ZONES MODEL DELAY-SEC.

THE DELAY (POWER UP) (STARTUP) TIME MARKED ON THE INSTALLATION WIRING DIAGRAM OF THE SMOKE DETECTOR OR ON THE INSTALLED SMOKE DETECTOR(S) IS TO BE USED.

PENDING UL GRADES FOR THE GEM-P3200
BURGLARY LOCAL - GRADE A
POLICE STATION - GRADE A
HOUSEHOLD BURGLARY ALARM CONTROL UNIT - GRADE A
HOUSEHOLD FIRE WARNING SYSTEM CONTROL UNIT REFER TO W588 FOR INSTALLATION REQUIREMENTS

TERMINAL	FUNCTIONS	DESCRIPTION
E14	RECHG	+12V BATT. POWER
E18	RECHG	BATTERY TEST OUTPUT
E7	PS	NO. AC INPUT
E4	US	IN USE
E10	RECHG	BATT. START
E4	RECHG	BATT. LUG
E4	RECHG	RECHG LUG
E22	RECHG	RESET-RELAY COMMON

- 1.) END-OF-LINE RESISTORS, 2200 OHMS, RED, RED, 5%, 1/2W, (EOL2,2K) ALSO INSTALLED IF ZONE NOT USED IN PANEL OR EZM, (INCLUDING FIRE AND PANIC). DO NOT INSTALL EOL RESISTOR ON FIRE ZONE IF USING FT2200 EOL RELAY.
- 2.) COMBINED STANDBY CURRENT= AUX POWER + REMOTE POWER + RESET RELAY + FIRE POWER.
- 3.) BELL CURRENT MAY BE INCREASED BY SUBTRACTING AN EQUAL AMOUNT FROM THE STANDBY CURRENT.
- 4.) SYSTEM MUST BE TESTED AT LEAST ONCE A WEEK IN THE AC/BATTERY MODE AND IN THE BATTERY-ONLY MODE. (CONTACT CENTRAL STATION PRIOR TO TESTING)
- 5.) CONTACTS 2A/24VDC RESISTIVE (CUT JUMPER FOR DRY CONTACT)
- 6.) FOR U.L. RESIDENTIAL FIRE, CUT 'PS' JUMPER AND INSTALL SHUNT ACROSS JP-6 HEADER.
- 7.) FOR SUPERVISION PROGRAM 'SUPERVISED BELL OUTPUT' UNIT INTENDED TO BE MOUNTED ON THE WALL VERTICALLY
- 8.) REFER TO WB17 FOR COMPATIBLE TWO WIRE SMOKE DETECTORS. DO NOT MIX DIFFERENT MODELS.
- 9.) RECOMMENDED BATTERIES: YUASA NP4-12 AND NP7-12. BATTERIES MUST BE REPLACED EVERY FIVE YEARS.
- 11.) THIS PANEL SHALL BE CHECKED BY A QUALIFIED TECHNICIAN AT LEAST ONCE EVERY THREE YEARS.
- 12.) AUX. POWER AND FIRE POWER VOLTAGE RATING 12.5VDC TO 17.0VDC.
- 13.) THIS PANEL SUPPORTS ONLY ONE SMOKE DETECTOR IN ALARM FOR EACH ZONE.
- 14.) CUT TO DISABLE BELL SUPERVISION. DO NOT CUT IN U.L. INSTALLATIONS.

- POWER UP SEQUENCE
- 1.) CONNECT AC POWER
 - 2.) INSTALL STANDBY BATTERY

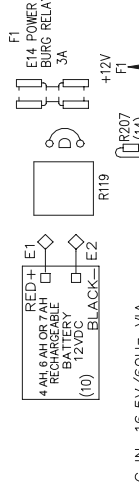
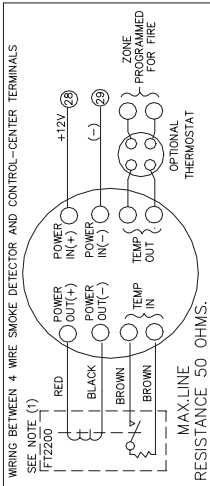

AC IN, 16.5V/60Hz VIA TRF-11, OR TRANSFORMER CLASS Z CONNECT TO SWITCHED OUTLET (7) 12.5VDC TO 10.9VDC

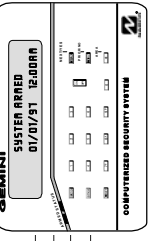
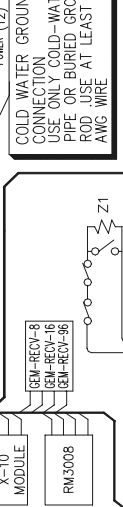
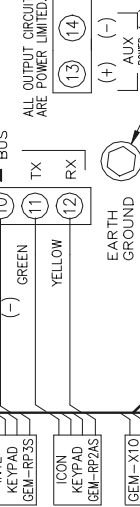
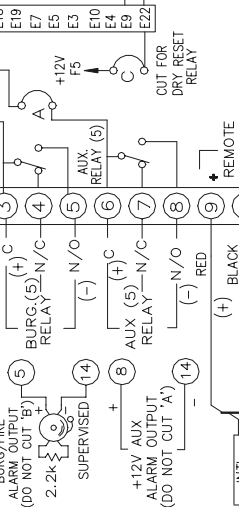

GEM-RP1CA62 (2 LINE LCD KEYPAD)

MAX/MIN 13.6VDC TO 8.3 VDC

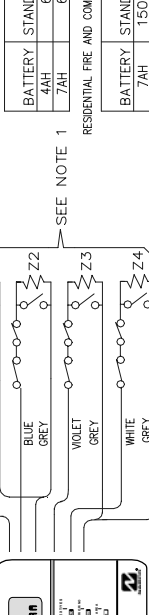
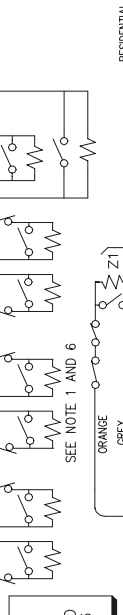
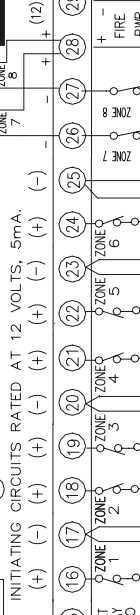
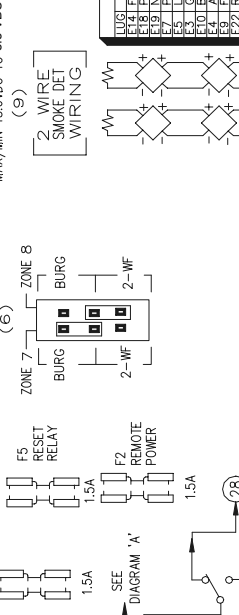

RESIDENTIAL AND COMMERCIAL BURGLARY/ALARM CURRENT CHART

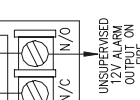
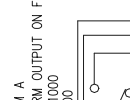
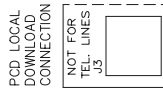

WARNING
TO PREVENT RISK OF ELECTRIC SHOCK DISCONNECT TELEPHONE LINES PRIOR TO SERVICING

RESIDENTIAL AND COMMERCIAL BURGLARY/ALARM CURRENT CHART	
BATTERY	STANDBY CURRENT
4AH	650mA
7AH	650mA

RESIDENTIAL FIRE AND COMBINATION RESIDENTIAL BURGLARY AND FIRE STANDBY/ALARM CURRENT CHART	
BATTERY	STANDBY CURRENT
7AH	150mA (3)
	650mA (3)

LA1499C



NAPCO LIMITED WARRANTY

NAPCO SECURITY SYSTEMS, INC. (NAPCO) warrants its products to be free from manufacturing defects in materials and workmanship for *thirty-six months* following the date of manufacture. NAPCO will, within said period, at its option, repair or replace any product failing to operate correctly without charge to the original purchaser or user.

This warranty shall not apply to any equipment, or any part thereof, which has been repaired by others, improperly installed, improperly used, abused, altered, damaged, subjected to acts of God, or on which any serial numbers have been altered, defaced or removed. Seller will not be responsible for any dismantling or reinstallation charges.

THERE ARE NO WARRANTIES, EXPRESS OR IMPLIED, WHICH EXTEND BEYOND THE DESCRIPTION ON THE FACE HEREOF. THERE IS NO EXPRESS OR IMPLIED WARRANTY OF MERCHANTABILITY OR A WARRANTY OF FITNESS FOR A PARTICULAR PURPOSE. ADDITIONALLY, THIS WARRANTY IS IN LIEU OF ALL OTHER OBLIGATIONS OR LIABILITIES ON THE PART OF NAPCO.

Any action for breach of warranty, including but not limited to any implied warranty of merchantability, must be brought within the six months following the end of the warranty period.

IN NO CASE SHALL NAPCO BE LIABLE TO ANYONE FOR ANY CONSEQUENTIAL OR INCIDENTAL DAMAGES FOR BREACH OF THIS OR ANY OTHER WARRANTY, EXPRESS OR IMPLIED, EVEN IF THE LOSS OR DAMAGE IS CAUSED BY THE SELLER'S OWN NEGLIGENCE OR FAULT.

In case of defect, contact the security professional who installed and maintains your security system. In order to exercise the warranty, the product must be returned by the security professional, shipping costs prepaid and insured to NAPCO. After repair or replacement, NAPCO assumes the cost of returning products under warranty. NAPCO shall have no obligation under this warranty, or otherwise, if the product has been repaired by others, improperly installed, improperly used, abused, altered, damaged, subjected to accident, nuisance, flood, fire or acts of God, or on which any serial numbers have been altered, defaced or removed. NAPCO will not be responsible for any dismantling, reassembly or reinstallation charges.

This warranty contains the entire warranty. It is the sole warranty and any prior agreements or representations, whether oral or written, are either merged herein or are expressly cancelled. NAPCO neither assumes, nor

authorizes any other person purporting to act on its behalf to modify, to change, or to assume for it, any other warranty or liability concerning its products.

In no event shall NAPCO be liable for an amount in excess of NAPCO's original selling price of the product, for any loss or damage, whether direct, indirect, incidental, consequential, or otherwise arising out of any failure of the product. Seller's warranty, as hereinabove set forth, shall not be enlarged, diminished or affected by and no obligation or liability shall arise or grow out of Seller's rendering of technical advice or service in connection with Buyer's order of the goods furnished hereunder.

NAPCO RECOMMENDS THAT THE ENTIRE SYSTEM BE COMPLETELY TESTED WEEKLY.

Warning: Despite frequent testing, and due to, but not limited to, any or all of the following; criminal tampering, electrical or communications disruption, it is possible for the system to fail to perform as expected. NAPCO does not represent that the product/system may not be compromised or circumvented; or that the product or system will prevent any personal injury or property loss by burglary, robbery, fire or otherwise; nor that the product or system will in all cases provide adequate warning or protection. A properly installed and maintained alarm may only reduce risk of burglary, robbery, fire or otherwise but it is not insurance or a guarantee that these events will not occur. CONSEQUENTLY, SELLER SHALL HAVE NO LIABILITY FOR ANY PERSONAL INJURY, PROPERTY DAMAGE, OR OTHER LOSS BASED ON A CLAIM THE PRODUCT FAILED TO GIVE WARNING. Therefore, the installer should in turn advise the consumer to take any and all precautions for his or her safety including, but not limited to, fleeing the premises and calling police or fire department, in order to mitigate the possibilities of harm and/or damage.

NAPCO is not an insurer of either the property or safety of the user's family or employees, and limits its liability for any loss or damage including incidental or consequential damages to NAPCO's original selling price of the product regardless of the cause of such loss or damage.

Some states do not allow limitations on how long an implied warranty lasts or do not allow the exclusion or limitation of incidental or consequential damages, or differentiate in their treatment of limitations of liability for ordinary or gross negligence, so the above limitations or exclusions may not apply to you. This Warranty gives you specific legal rights and you may also have other rights which vary from state to state.

