

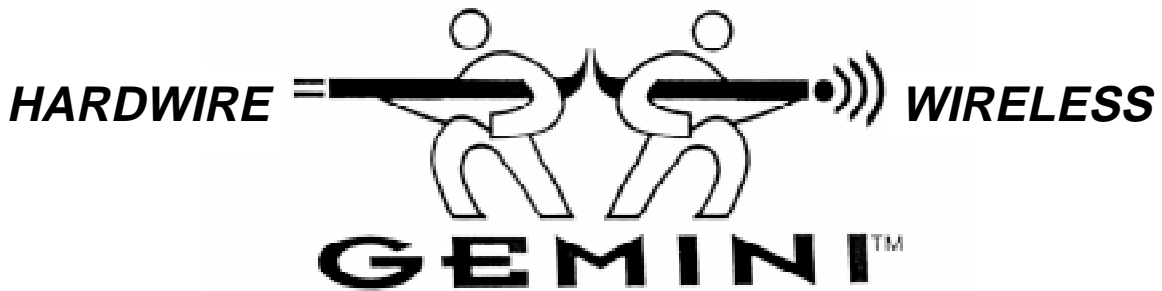

# INSTALLATION INSTRUCTIONS

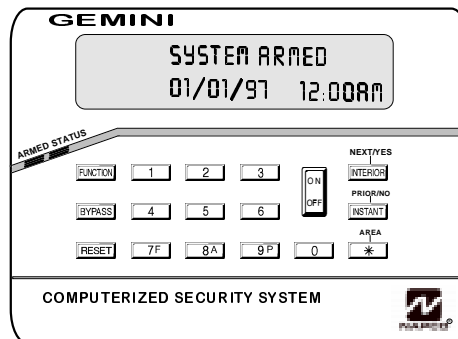

## GEM-P1632 CONTROL PANEL/COMMUNICATOR



GEM-RP1CAe2 Keypad

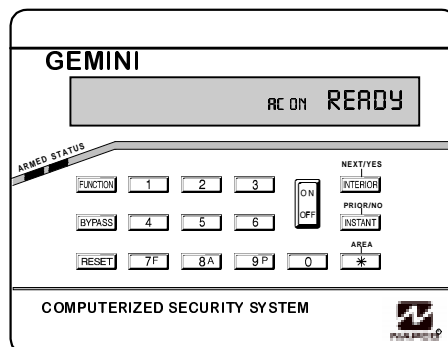

GEM-RP2ASe2 Keypad



**NAPCO Security Systems, Inc.**

**333 Bayview Avenue, Amityville, New York 11701**

**For Sales and Repairs, call toll free: (800) 645-9445**

**For direct line to Technical Service, call toll free: (800) 645-9440**

**Internet: <http://www.napcosecurity.com>**

# TABLE OF CONTENTS

**INTRODUCTION.....4**

*General Description* .....4

*Features*.....4

*Specifications*.....6

*Ordering Information*.....7

*Summary of UL Requirements*.....8

**INSTALLATION .....9**

*Mounting* .....9

*Wiring*.....10

*Wireless Systems* .....10

*Typical Residential Fire Installation*.....10

*Typical Partitioned Installation* .....10

*UL Commercial-Burglary Installations*.....11

*Testing the System* .....12

**WIRING CONNECTIONS .....13**

*Battery*.....13

*Transformer*.....13

*Siren/Bell Output*.....13

*Auxiliary Power* .....13

*PGM Outputs* .....13

*Remote Bus* .....14

*Earth Ground*.....14

*Basic Zone Configuration*.....15

*EZ Zone Doubling Configuration*.....15

*4-Wire Smoke Detectors*.....16

*2-Wire Smoke Detectors*.....16

*Telephone Lines*.....17

**KEYPAD CONFIGURATION MODE .....18**

*Keypad Installation*.....18

*Configuring the Keypads*.....18

**BASIC OPERATION .....21**

*User Codes & Zone Descriptions*.....21

*Arming and Disarming the System*.....22

*Bypassing Zones*.....24

*Alarm Indication* .....24

*Function Mode* .....24

*Keypad Messages*.....26

**STANDBY-BATTERY CALCULATION WORKSHEET .....27**

**WIRING LEGEND .....28**

**KEYPAD PROGRAMMING MODES.....29**

**GEM-P1632 WIRING DIAGRAM .....33**

Refer to accompanying GEM-P1632 Programming Instructions (WI897) for programming information.

**NOTE: THESE INSTALLATION INSTRUCTIONS ARE INTENDED AND WRITTEN FOR THE PROFESSIONAL INSTALLER HAVING SUITABLE EXPERIENCE AND INSTALLATION EQUIPMENT. THE UNIT IS DESIGNED TO BE PROGRAMMED USING AN IBM-COMPATIBLE COMPUTER WITH NAPCO PCD3000 SOFTWARE. AFTER PROGRAMMING, BE SURE TO RUN THE PCD3000 ERROR-CHECK UTILITY TO GUARD AGAINST PROGRAMMING CONFLICTS FOR THE TYPE OF SERVICE SELECTED FOR THE INSTALLATION.**

# INTRODUCTION

## GENERAL DESCRIPTION

Napco's Gemini GEM-P1632 is a state-of-the-art microcomputer-based burglary and residential fire alarm control panel of modular design. Integrally an 8-zone panel, it will support up to 32 zones with the use of zone doubling, optional zone expansion modules, wireless receiver modules and/or GEM-RP1CAe2 Keypads. Each panel includes an integral digital communicator.

The control panel features programmable area partitioning. That is, the system may be divided into up to two discrete multiple-zone areas, each allowing access by only those users programmed for their respective area.

Opening Suppression and Closing Suppression, available through Napco Quickloader software, suppress reporting within programmed "windows". Conversely, Exception Reporting can transmit a "fail to close" if the panel is not armed within programmed intervals and, similarly, a "fail to open" if the panel is not disarmed within programmed intervals. Furthermore, the panel can be programmed to automatically arm either area at any time. A log containing up to 400 events (accessible through Quickloader™ software) monitors control-panel activity referenced to a precision real-time clock. A detailed event history may be displayed at the computer, using Napco's PCD3000 Quickloader Software.

Keypads feature a liquid-crystal display for messages. In normal use, the LCD shows zone identification and status messages. Conventional LEDs and a sounder are also provided for annunciation.

Data may be quickly and easily downloaded to the control panel using a PC-compatible computer with Napco's PCD3000 Quickloader software and PCI2000 computer interface. Or, the panel may be programmed using the keypad in its secondary mode of operation. In the keypad programming modes (there are two: Dealer and User), the LCD shows memory address, data values, programming prompts, and the alphanumeric characters required for entering up to 32 user codes and custom zone descriptions.

**NOTE:** Failure to install and program as described in this manual for UL-listed systems voids the listing mark of Underwriters Laboratories, Inc.

## FEATURES

### *Control Panel Features*

- ✓ Eight end-of-line-resistor burglary zones programmable for Area (expandable to sixteen end-of-line resistors with zone doubling), Exit/Entry Delay, Interior, Follower, Day Zone, Chime, Fire options, Swinger Shutdown, Zone Anding and a variety of other features.
- ✓ Supports up to 32 zones with optional zone-expansion modules, wireless receiver modules and 4-zone keypads.
- ✓ Supports up to 32 individually coded users, each with a programmable authority level.
- ✓ Supports three outputs (Bell, PGM1 and PGM2) and up to 8 external relay outputs (using Relay Module RB1000).
- ✓ Supports three keypad panics: Fire, Police & Auxiliary
- ✓ Supports two independent area partitions.
- ✓ Supports up to seven separate access stations (keypads) by up to 32 users.
- ✓ Supports up to 8 separately-addressable X-10 devices with the GEM-X10 KIT and PC04 interfaces.
- ✓ English-language prompts & system status messages.
- ✓ User-customized zone descriptions, re-programmable as required.
- ✓ Supports 2-wire and 4-wire smoke detectors.
- ✓ Reports alarms, restores and troubles by zone.
- ✓ 400 Event Log.
- ✓ Two programmable entry delay times.
- ✓ One Interior Zone Group per Area

- ✓ Dynamic battery test interrupts charging and places battery under load every four hours.
- ✓ Chime by zone; programmable duration.
- ✓ Quickloader programmable.
- ✓ 2 PGM outputs.
- ✓ Supports Gemini Wireless Devices

### ***Communicator Features***

- ✓ Compatible with all major receiver formats, including 4/2, SIA and Point ID.
- ✓ Rotary dial and TouchTone™ with Rotary backup.
- ✓ Three 20-digit telephone numbers.
- ✓ Backup Reporting; Double Reporting; Split Reporting.
- ✓ 32 User Codes with Opening/Closing -Reporting by user.
- ✓ AC Failure Reporting with programmable report delay.
- ✓ Supervised telephone line with programmable delay.
- ✓ Pager capability.

### ***Keypad Features***

- ✓ English-language LCD display; LED and sounder annunciators.
- ✓ Supports up to seven 4-wire keypads.
- ✓ Provisions for fire, police and auxiliary panic alarms.
- ✓ Integral 4-zone EZM included in each keypad (GEM-RP1CAe2 only).
- ✓ Fault-Find diagnostics simplify troubleshooting.

# SPECIFICATIONS

## GEM-P1632

*Operating Temperature:* 0-49°C (32-120°F)

*Input Power:* 16.5VAC via CLASS 2 Plug-In 20VA, 40VA or 50VA Transformer

*Loop Voltage:* 10-13Vdc

*Loop Current:* 3mA without Zone Doubling, 2.4mA with Zone Doubling using a 2.2K Ohm end-of-line resistor (Model EOL2.2K); 5mA for 2-wire smoke-detector zones; 1.4 mA using a 3.9K Ohm resistor (Model EOL 3.9K) with Zone Doubling

*Loop Resistance:* 300W max.; 50W for 2-wire smoke-detector zones

*Alarm Voltage Output:* 1

*Programmable Negative Outputs:* 2

*Auxiliary Power Output:* 11.7 VDC to 12.5 VDC

*Remote Power Output:* 12 VDC regulated (for keypads)

*Combined Standby Current (Remote Power + Aux. Power + Reset Relay Power):* See following charts.

RESIDENTIAL BURGLARY & COMMERCIAL BURGLARY				
16.5VAC TRANSFORMER	BATTERY (12 VDC)	STANDBY CURRENT	ALARM CURRENT	STANDBY TIME
40VA/50VA	7 AH	650 mA	2.0 A	4 Hours
20VA *	7 AH	500 mA	2.0 A	4 Hours
20VA *	7 AH	500 mA	2.0 A	6 Hours

RESIDENTIAL FIRE				
16.5VAC TRANSFORMER	BATTERY (12 VDC)	STANDBY CURRENT	ALARM CURRENT	STANDBY TIME
40VA/50VA	7 AH	120 mA	520 mA <sup>(1)</sup>	24 Hours
40VA/50VA *	Two 7 AH	360 mA	280 mA <sup>(1)</sup>	24 Hours
20VA *	7 AH	120 mA	360 mA <sup>(1)</sup>	24 Hours
20VA *	Two 7 AH	360 mA	120 mA <sup>(1)</sup>	24 Hours

**NOTE:** <sup>(1)</sup> Alarm current can be increased by reducing standby current by the same amount.

current can be increased by the same amount.

**RESIDENTIAL FIRE PROGRAMMING OPTION:** Refer to GEM-P1632 Programming Instructions (WI897) for programming information. This option changes the operation of the power supply in alarm conditions to optimize performance. In installations that do not monitor fire conditions (Residential and Commercial Burglary) U. L. allows the battery to be depleted in alarm conditions when AC is present. To prevent the regulator and rectifier from exceeding 75% of their rated temperature the regulator drops to 10V causing the battery to support the entire alarm current. In installations that do monitor fire conditions (Residential Fire) U.L. does not allow the battery to be depleted in alarm conditions when AC is present. Therefore when this bit is set the regulator is not dropped to 10V during alarm conditions. When this bit is set the current specifications for Residential Fire should not be exceeded. If the specifications are exceeded when a 40VA or 50VA transformer is used the regulator may exceed 75% of its rated temperature up to 85% of its rated temperature at which point the regulator will protect itself by current limiting. This would cause the battery to deplete, but no damage would occur to the panel. If a 20VA transformer is used and the Residential Fire current specifications are exceeded then the Transformer VA rating may be exceeded thereby damaging the transformer.

\* Not evaluated by U.L.

**EZM Module:**

GEM-EZM816: Input, 50mA

**Keypad Current:**

GEM-RP1CAe2: 100mA; 35mA if back lighting is disabled (cut W1, W2 & W3)

PGM Output: 5mA, 12V Special Application

**Maximum Number of Keypads: 7**

Maximum Wiring Length for each run (#22AWG): 1000' divided by total number of keypads and EZMs on run

**Keypad Dimensions:** 4" x 5" x 1" (HWD); 11.1cm x 14.9cm x 2.7cm (HWD)

## ORDERING INFORMATION

### **System Components**

**GEM-P1632:** Residential UL-Listed Burg and Fire Control Panel.

**GEM-P1632M:** Mercantile Burg

**GEM-RP1CAe2:** 32-Character LCD Burg & Fire Keypad with 4 EOL Zones.

**GEM-RP2ASe2:** LCD Burg & Fire Keypad with remote panic.

### **Optional Accessories and Peripherals**

**GEM-EZM816:** 4-16 Zone Expansion Zone Module \*

**GEM-EVA 1:** Electronic Voice Annunciator \*

**GEM-RECV8:** Wireless Receiver, 8 Zones \*

**GEM-RECV16:** Wireless Receiver, 16 Zones \*

**GEM-RECV96:** Wireless Receiver, 96 Zones \*

**GEM-TRANS2:** Window/Door Transmitter, 2-Point \*

**GEM-TRANS4:** Window/Door Transmitter, 4-Point \*

**GEM-KEYF:** Key Fob Transmitter \*

**GEM-SMK:** Wireless Smoke Detector \*

**GEM-PIR:** Wireless PIR \*

**GEM-DT:** Wireless Dual-Technology Sensor \*

**GEM-GB:** Wireless Glass-Break Detector \*

**GEM-X10KIT:** X-10 Interface \*

**RM3008:** Relay Module (in enclosure)

**M278:** Line-Reversal Module

**PS3002:** Power-Supply Module, 13.2Vdc, 1.9A \*

**EOL2.2K:** End-of-Line Resistor Assy., 2.2kW, for Fire Circuit

**FT2200:** End-of-Line Relay/Resistor Supervisory Module \*

**RB1000:** Relay Board \*

**RBATH1:** Dual Battery Harness

**RPB-3:** Universal Junction Box

**TRF11:** Transformer, 16.5Vac/40VA, Class 2

**TRF14:** Transformer, 16.5Vac/50VA, Class 2

**WL1:** Wire Assembly with Lug Connector, 20"

**VERI-PHONE:** Two-Way Voice/Listen-In Module \*

**PCD3000:** Downloading Software for IBM PC-Compatible

**PCI2000/3000:** Software with Interface for IBM PC-Compatible Computer

**PCI-MINI:** Notebook Computer Interface

**W834-1:** Keypad Cable, plug-in (20")

**OI163:** Instruction Manual, GEM-P1632

**OI192:** Instruction Manual, GEM-RP2ASe2

**OI193:** Instruction Manual, GEM-RP1CAe2

**WI897:** GEM-P1632 Programming Instructions

**WIZARD IIe:** Telephone Interface Module \*

\*Not investigated by UL.

### **UL Listings**

Household Burglar Alarm System Units: UL1023

Household Fire Warning System Units: UL985

Local Burglar Alarm Units and Systems: UL609 \*\*

Central Station Burglar Alarm Units: UL1610 \*\*

Police Station Alarm Units: UL365 \*\*

\*\* Pending



**Smoke Detectors, 4-Wire:**

1. ESL 445AT, 445C, 445CT, 445CR, 445CRT
2. Gentex 812, 812T, 812P, 812PT, 812PH; 8120, 8120T, 8120P, 8120PT, 8120PH
3. Hochiki America SLG-12 with YBC-RL4-RA Base
4. System Sensor 2312/24T; 1412; 1412TH; 2412TH

*Subtract total smoke-detector alarm current from available standby current.*

**Note:** Any normally-open devices that do not require power from the control panel, such as pull stations, waterflow and thermostats may be used if acceptable to the Authority having Jurisdiction.

**UL Compatible Smoke Detectors (Providing UL Recognition or Listing)**

Manufac- turer	4-Wire Smoke Detector		2-Wire Smoke Detector *		Smoke Detector Base
Sentrol	449AT	449CLT	712U	731U	701U 702U 702RE 702RU
	449C	449CSLT	722U		
	449CRT	449CTE	732U		
	449CST	741U	711U		
	449CSRT	742U	721U		
	449CSRH		721UT		
	449CSST				
System Sensor	1112	2112T	2100	1100	
	2112	2112TSRB	2100T		

**Note:** \* Voltage Rating: 8.5–13.3 VDC, Maximum Number of Detectors: 10

**SUMMARY OF UL REQUIREMENTS****Residential**

- ✓ Recognized Limited-Energy Cable for initiating, indicating and supplementary circuits.
- ✓ Initiating loops supervised if longer than 3 feet
- ✓ FT2200 End-of-Line Relay for Fire (if using 4-wire smoke detectors)
- ✓ Minimum alarm timeout of 5 minutes
- ✓ Maximum exit time: 60 seconds
- ✓ Maximum entry time: 45 seconds
- ✓ Do not program "Swinger Shutdown", "Force Arming", "Selective Bypass", "Group Bypass", or "50 ms Loop Response"
- ✓ "Abort Delay" may not exceed 45 seconds
- ✓ Program "Disable Callback Download"
- ✓ Automatic dialer may not dial a police station number that has not been dedicated for such service
- ✓ System must be tested at least weekly under AC/battery and Battery-Only conditions
- ✓ Replace the rechargeable battery at least every 5 years
- ✓ If the battery is heavily discharged, replace it or have it tested by a qualified technician
- ✓ For silent panic, connect only to UL-listed holdup devices
- ✓ All zones must be programmed for "Priority"
- ✓ Do not program any zones for "Keyswitch Arming"
- ✓ System must be serviced at least once every 3 years
- ✓ Residential Fire and Combination Residential Fire & Burglary must program "Residential Fire"
- ✓ Keypad Expansion (EZM) Zones are not to be used as fire zones

# INSTALLATION

**CAUTION:** This equipment generates and uses radio-frequency energy. If not installed using conventional installation practices for RF devices, it may cause interference to radio and television reception. It has been tested and found to comply with the limits for a Class A computing device pursuant to Subpart B of Part 15 of FCC Rules, which are designed to provide reasonable protection against such interference. However, there is no guarantee that interference will not occur in a particular installation. If it has been found to cause interference to radio or television reception, which can be determined by removing and reapplying AC and battery power to the equipment, the installer should try to correct the interference by one or more of the following measures: reorient the receiving antenna; connect the power transformer to a different outlet so that the control panel and receiver are on different branch circuits; relocate the control panel with respect to the receiver.

## MOUNTING

### *Control Panel*

Choose a mounting location accessible to (a) a continuously-powered AC source, (b) system ground, a steel or copper ground rod, ideally no further away than 10 feet, and (c) telephone lines (keep telephone wiring away from keypad wires). Remove appropriate knockouts for cables. Place the control panel at a convenient viewing height and mark the mounting holes. Attach the enclosure using screws suitable for the mounting surface.

### *Grounding*

Connect the control-panel grounding screw to a long steel or copper ground rod driven deeply into the earth. Do not use a gas pipe, plastic pipe or ac ground connections. Use at least 16-gauge wire. Make the run as short and direct as possible, without any sharp bends in the wire.

### *Tamper Switches*

Tamper switches may be installed to prevent opening of the control-panel door or removal of the cabinet from the wall. Ideally, tamper switches should be connected to a zone that is active at all times, thus it may be necessary to program that zone as a 24-Hour Zone or Day Zone. When used on a normally-open zone, normally-closed tamper switches (open when set) should be wired in parallel. On a normally-closed zone, install Napco TPS-2 normally-open tamper switches (closed when set) in series.

There are two places in the cabinet to mount tamper switches: (1) To prevent cabinet removal from the wall, there are three mounting holes on the left side of the cabinet, another hole on the back that allows the switch button to contact the wall. (2) To prevent opening the cabinet door, there are three mounting holes on the right side of the cabinet. When mounted, the switch button should contact the inside of the door. Be sure to alert the user that opening the enclosure door will cause a tamper alarm. Note: Each tamper switch is furnished with three machine screws for mounting, and one self-tapping screw. The sole purpose of the self-tapping screw is to tap the holes for the machine screws; it may be discarded after use.

### *Keypad*

A keypad should be located near each exit/entry door. The keypad features a handy pull-up reference label. Before mounting the keypad onto the wall, push the Sliding Label Plate (with label and felt backing affixed and handle facing forward) down the guides at the rear of the keypad until it snaps into place. Once installed, the Sliding Label Plate cannot be removed without first removing the keypad from the wall. Note: (1) The keypad fire and panic keys should not be considered a substitute for a listed manual initiating device, such as a pull box. (2) Each GEM-RP1CAe2 includes provisions for four additional zones. See ADDING EXPANSION ZONES.

If installing onto a double-gang box, insert mounting screws through the two vertical elongated holes on the left side of the case and into the box. If the box is visible when viewed from the front, adjust the keypad vertically and tighten the screws. Then, using hardware suitable for the mounting surface, add one or two screws at the right side of the keypad case directly into the wall to ensure a secure installation. Note: Do not overtighten the screws! Uneven walls may cause the keypad case to distort.



## WIRING

Wire keypad(s), zones, expansion zone modules and output devices as shown on the Wiring Diagram. Note that the Wiring Diagram contains important information not available elsewhere in this manual.

**CAUTION:** Do not run telephone wiring near speaker wires; do not run keypad wiring with loop wiring.

### Adding Expansion Zones

GEM-P1632-Series control panels will handle up to 8 zones as is, however this number may be increased to as many as 32 programmable zones using optional expansion zone modules (EZMs).

### WIRELESS SYSTEMS (NOT EVALUATED BY U.L.)

With the addition of at least one GEM-RECV series receiver, the GEM-P1632 will support up to 32 wireless transmitters. The panel can accommodate one or two receivers within the premises, responding to the one with the stronger transmitter signal. If any transmitters are selected for the default program, a GEM-RECV receiver will automatically be programmed. The keypad can display the status of any transmitter, indicating the condition of the zone (normal or open) and transmitter troubles (low battery, tamper or supervisory failure), and signal strength of the last transmission. A receiver failure will be indicated by "E06-NN" ("no response", with NN representing the receiver number).

### TYPICAL RESIDENTIAL FIRE INSTALLATION (WHERE PERMITTED BY LOCAL CODES)

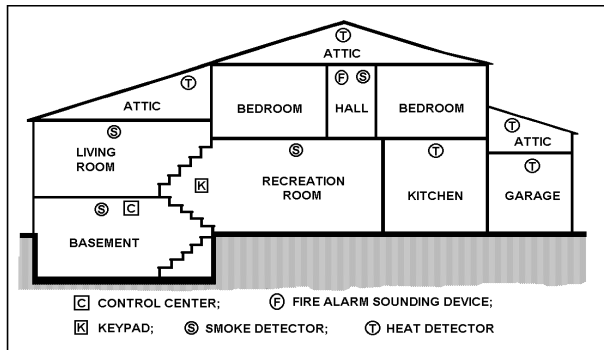

At least one smoke detector should be installed directly outside each sleeping area. If there is more than one floor, additional smoke detectors should be installed on each level, including the basement. The living-area and basement smoke detectors should be installed near the stairway of the next upper level.

For increased protection, additional detectors should be installed in areas other than those required, such as the dining room, bedrooms, utility room, furnace room, and hallways. Heat detectors, rather than smoke detectors, are recommended in kitchens, attics, and garages due to conditions that may result in false alarms and improper operation. Large areas and areas with partitions, ceiling beams, doorways, and open joists will require additional detectors.

Refer to NFPA Standard No. 74 (National Fire Protection Association, Batterymarch Park, Quincy, MA 02269) for additional information, including proper mounting of detectors.

### TYPICAL PARTITIONED INSTALLATION

Described and illustrated here are an example of a partitioned system with common-area protection of the control-panel room. This system meets UL requirements for a partitioned installation.

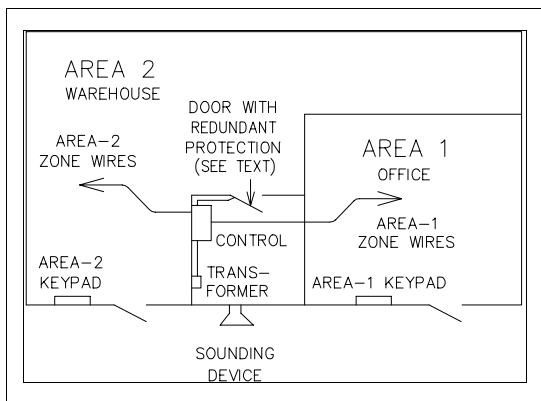

- ☞ Both areas must be owned and managed by the same person(s).
- ☞ Both areas must be part of one building at one street address.
- ☞ The control panel and all wiring protecting each partitioned area must be confined to the respective area and may not encroach upon the other area. This requires that the control panel room have redundant protection; that is (a) multiple sets of door contacts, each wired to a separate zone and (b) one of those zones programmed for each area. In order to gain access to this protected area without causing an alarm, both partitions must be disarmed. In lieu of redundant protection, 24-Hour Zones may be used. Any zone protecting the control panel and transformer may not be programmed for bypass.
- ☞ The sounding device must be placed such that the bell test can be heard by all partitions. Note: NFPA 74 (Household Fire Warning Equipment) requires that a fire alarm audible device be installed indoors.
- ☞ The User Program Code is not to be given to anyone except the authority

responsible for all partitions.

## UL COMMERCIAL-BURGLARY INSTALLATIONS (PENDING)

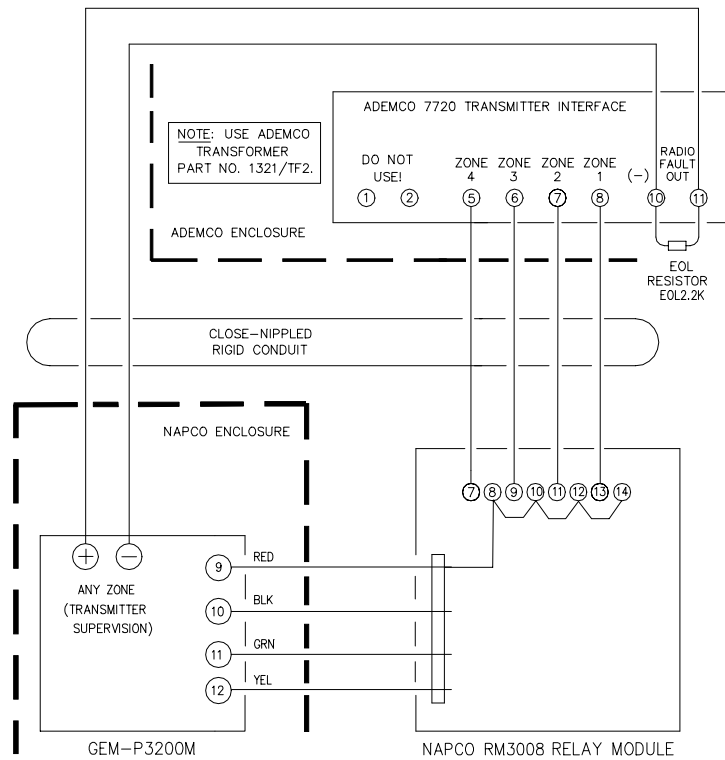

- ✓ Low-Battery Annunciation.
- ✓ An Ademco AB-12 Bell and Box (12-volt).
- ✓ Program Auto Bell Test on Arming.
- ✓ a maximum Entrance and Exit Delay of 60 seconds.

The GEM-P1632M can be used as part of a UL Central Station Grade C, B, or A installation. Normally, a digital communicator is classified as Grade C and may be classified Grade B if used with the specified Grade-A Local bell and bell housing. A UL Central Station Grade-A installation requires the use of a Napco RM3008 Relay Board and Ademco 7720 Radio System. Refer to the installation instructions furnished with each component for respective installation requirements.

For a UL Commercial Grade-A Police Station Connection, refer to GRADE-A LOCAL MERCANTILE INSTALLATIONS, which follows. Use the M278 Line-Reversal Monitor to provide basic line security; refer to the instructions accompanying the M278 for other installation requirements.

For UL Commercial safe and vault applications, use a UL-listed shock sensor suitable for metal enclosures. Install tamper switches on front and rear of control-panel enclosure.

### Grade-A Local Mercantile Installations

A Grade-A Local Mercantile installation must use at least a 6.0AH standby battery. Programming must include Auto Bell Test on Arming. Trouble on Night Open may not be programmed for any zone.

The minimum requirements for a listed Grade-A Local system include:

### Interfacing to the Ademco 7720 Long-Range Wireless System

The RM3008 may be used to interface the GEM-P1632M control panel to the Ademco 7720 transmitter in order to meet UL Central Station Grade-A or Grade-B requirements by using a digital communicator combined with one-way wireless. (Normally, a digital communicator is Grade C, and may be Grade B if the specified Grade-A local bell is used.) Refer to the wiring diagram which follows, and to the instructions furnished with the Napco and Ademco equipment for further information concerning the DACT, listed compatible receiver and formats, Grade-A local bell and bell housing. Enable Line Fault Test must be programmed.

### Central Station Grade-B Requirements (Pending)

Wiring to the Ademco 7720 transmitter must be enclosed in rigid conduit when outside walls, or in flexible conduit when inside walls or above ceilings, for the entire length up to the transmitter room. The transmitter room must be protected by a UL listed intrusion detection unit that is connected to one of the input channels of the Ademco 7720. Relays must be programmed to trip the Ademco 7720 for alarms on all protective circuits, including tampers, telco phone failure, 24-hour test timer, transmitter low battery and ac loss. (See PCD3000 External Relay Control screen.) One zone on the GEM-P1632M, programmed as a 24-Hour Zone, must supervise the radio.

### Central Station Grade-A Requirements (Pending)

In addition to Grade-B Requirements (above), one relay on the RM3008 must be programmed to trip the Ademco 7720 when the telephone line fails. Daily openings and closings are required to be transmitted by the Napco panel along with the 24-hour DACT test signal and DACT trouble conditions.

## TESTING THE SYSTEM

After installation is completed, test the system as follows.

1. Call the central station to inform them of the test.
2. Initiate an alarm, preferably on a zone that activates a steady siren, and verify proper signalling.
3. Call the central station to confirm their receipt of a good transmission.

**Note:** Be sure to test all enabled keypad panics.

### ***Signal Strength Testing/Wireless Systems***

To test the operation of wireless transmitters, proceed as follows. (Note: Wireless systems have not been investigated by UL.)

1. Enter the Fault-Find Mode.
  2. Fault a point of the transmitter to be tested by opening the loop. If the signal strength of the transmitter is 3 or greater, the keypad will beep.
  3. Restore the wireless point (close the loop). If the signal strength of the transmitter is 3 or greater, the keypad will beep.
- The transmitter signal strength will be displayed on a scale of 3-10 with 3 considered marginal and 10 considered excellent. If the signal strength is less than 3, the keypad will not beep and the strength will be displayed. Except in the Fault-Find Mode, signal strengths less than 3 will be entered into the system log.

# WIRING CONNECTIONS

## BATTERY

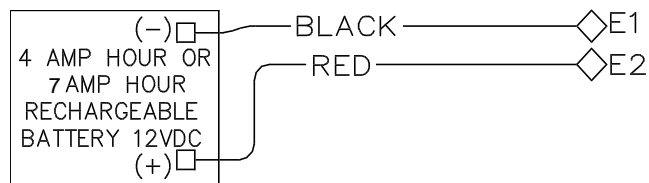

The RED (+) and BLACK (-) flying leads must be connected to a 12VDC 4-7 AH Rechargeable Battery, to serve as backup power in the event of AC Power Failure. **NOTE:** To calculate the available standby time refer to the Standby-Battery Calculation Worksheet at the back of this manual.

## TRANSFORMER

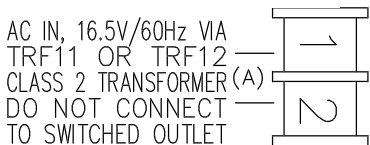

Connect a 16.5 VAC Transformer to Terminals 1 and 2, using a wire of #18 AWG. or less at a distance of 15 ft. or less from the control panel. **NOTE:** Do not connect to a switched outlet.

## SIREN/BELL POWER

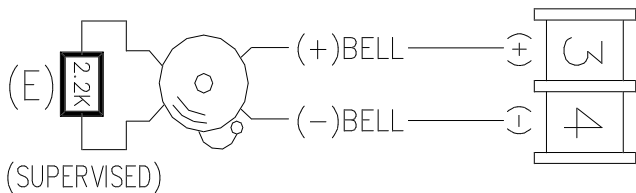

Connect the alarm sounding devices (self-contained sirens, speakers or a mechanical bells) to Terminals 3 and 4. Any self-contained siren requiring a 12 VDC input can be connected. When connecting a mechanical bell, it must be supervised using a 2.2k Ohm resistor. To connect 8 Ohm Speakers use a Siren Driver with the proper polarity observed. **NOTE:** Refer to the GEM-P1632 Wiring Diagram for alarm current specification.

## AUXILIARY POWER

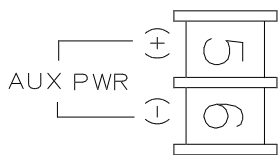

Connect the auxiliary devices (motion detectors, glass breaks, etc.) to Terminals 5 and 6. Auxiliary Power provides a filtered 12 VDC nominal output which is used for powering auxiliary devices. **NOTE:** To calculate the available standby time refer to the Standby-Battery Calculation Worksheet at the back of this manual.

## PGM OUTPUTS (PGM1 & PGM2)

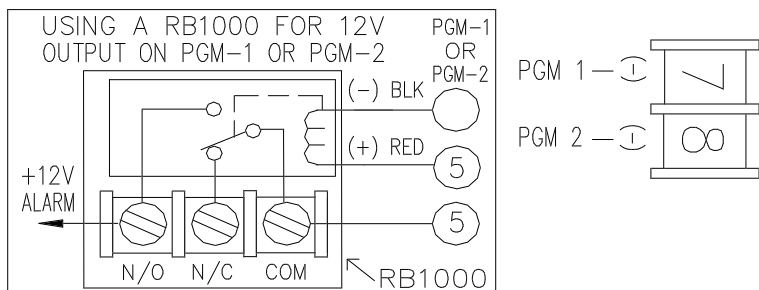

PGM1 and PGM2 are negative switched programmable outputs that can be activated depending on the programming options selected (see GEM-P1632 Programming Instructions). Connect the device controlled by the programmable output between terminal 5 (+) and the PGM output (-), either terminal 7 or 8. As an example, the connection to the RB1000 Relay Module is shown.

WIRING CONNECTIONS

## REMOTE BUS

WIRING CONNECTIONS

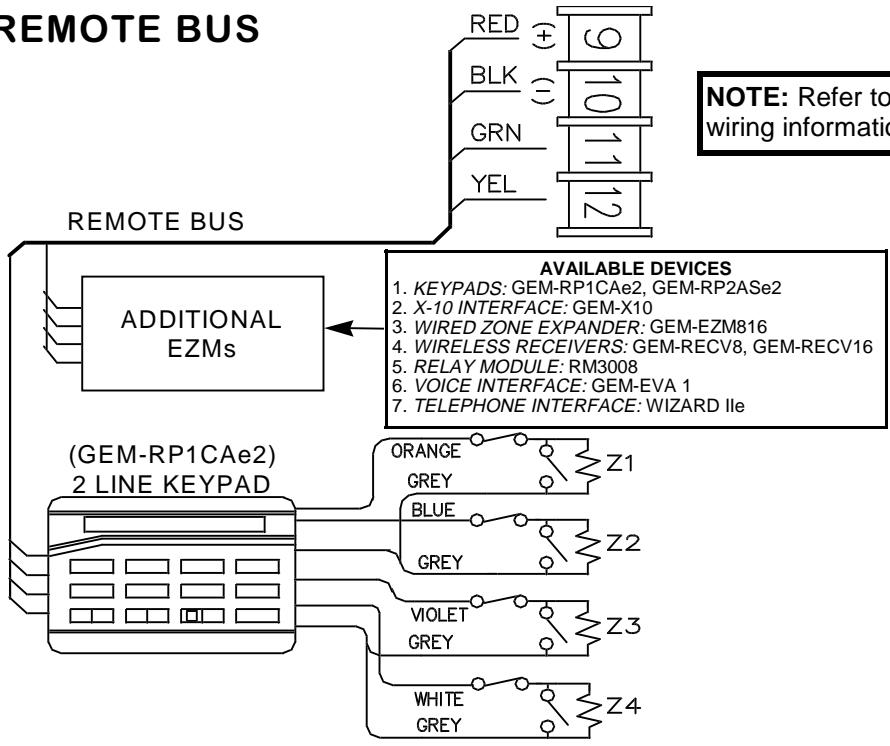

**NOTE:** Refer to the EZM Installation Instructions for specific wiring information.

Connect the available devices as shown above to the remote bus terminals (9, 10, 11 & 12). Observe the correct color wire connections. When connecting a keypad, first configure them accordingly (refer to the Keypad Configuration Mode at the back of this manual). Keypads should be located near every exit/entry door. Up to seven keypads may be connected if the longest cable run from the panel, to the farthest keypad (daisy chained or home-run) is less than 1000 feet. The maximum distance for seven keypads is 300 feet using 22 AWG. wire. **NOTE:** When running keypad wire, avoid wiring parallel to other types of wiring.

## EARTH GROUND

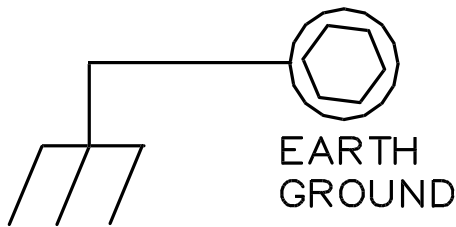

Connect the control panel EARTH GROUND screw to a metal cold-water pipe using at least a #16 AWG. wire. Do not use a gas pipe, plastic pipe or AC ground connections. Also, connect the circuit board to the metal enclosure. Connect a wire with a ground lug crimped or soldered onto one end of the EARTH GROUND screw to the cabinet. **NOTE:** Grounding connections should avoid bends in the grounding wire whenever possible.

**NOTE:** Do not use a gas pipe, plastic pipe or AC ground connections.

## BASIC ZONE CONFIGURATION

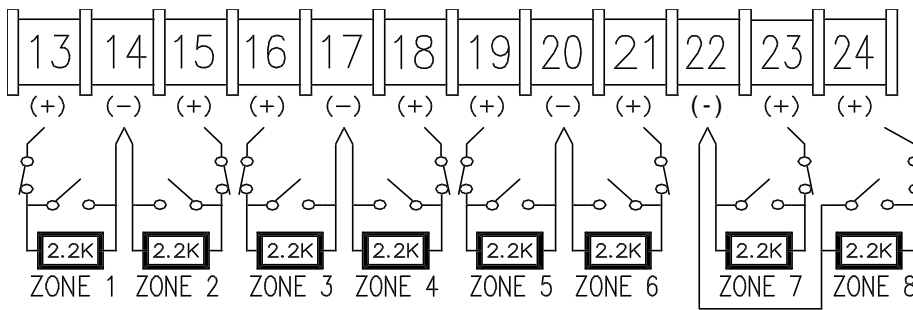

The basic zone configuration for the GEM-P1632 is 8 zones. Connect as shown above to terminals 13-24. Normally Closed (N.C.) devices may be wired in series or Normally Open (N.O.) devices may be wired in parallel. Use the 2.2K Ohm end-of-line (E.O.L.) resistor in each zone, if selected in programming (refer to the GEM-P1632 Programming Instructions). Zones 1-8 can be selected for a "Fast Loop Response (50 ms)" or a "Normal Loop Response (750 ms)". Other zone options include Zone Type (Entry/Exit, Interior, 24 Hour Protection, Trouble and Fire), Instant, Chime, Area Selection and PGM Output selection.

## EZ ZONE DOUBLING™ CONFIGURATION

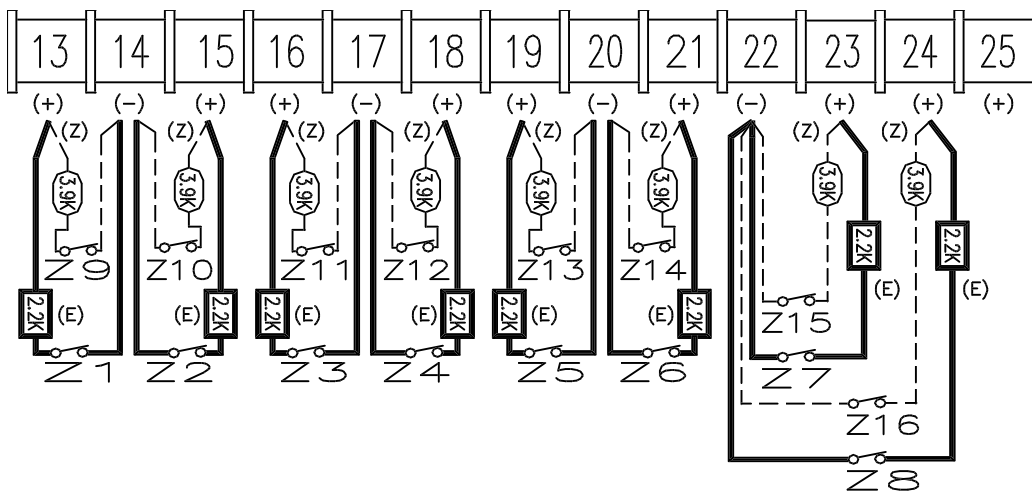

The control panel zone configuration may be expanded from 8 to 16 zones without the use of EZM Modules. To do so simply select "EZ Zone Doubling" in programming (refer to the GEM-P1632 Programming Instructions) and connect zones as shown above. **NOTE:** If both zones in a zone-pair configuration (ex: zones 1 & 9 in the above diagrams) are to be used, then normally closed devices must be wired to both zones. The 3.9K EOL resistor must be placed across the terminals of the higher zone and the 2.2K EOL resistor must be placed at the end of the loop of the lower zone.

If Normally open zones for fire or panic devices are required, then the lower zone (2.2K EOL resistor) must be used and the higher zone (3.9K EOL resistor) must not be programmed for any area.

**WARNING:** Assigning a fire zone or keyswitch zones to a zone doubled control will disable the respective complimentary zone. For example, if zone 8 is assigned as a fire zone, it will disable zone 16. If zone 3 is assigned as a fire zone, it will disable zone 11.

WIRING CONNECTIONS

# 4-WIRE SMOKE DETECTORS

4-WIRE SMOKE DETECTOR WIRING

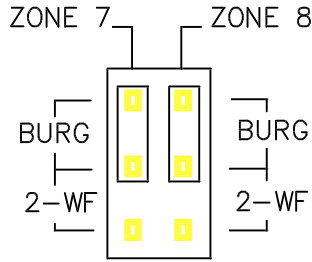
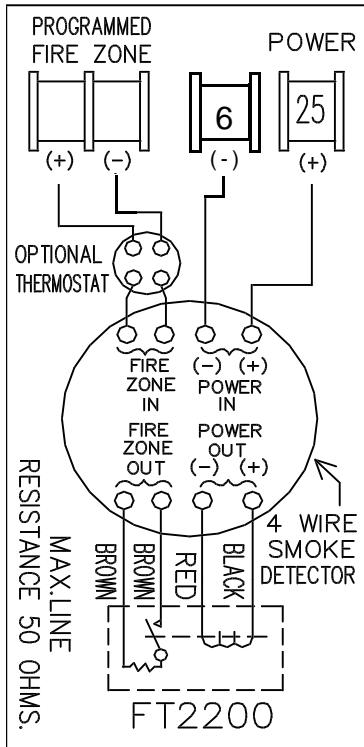

The GEM-P1632 can use conventional 12 VDC 4-wire smoke detectors. To use them, select fire zone programming option and do not select 2-wire smoke detector programming option for the desired fire zone (refer to the GEM-P1632 Programming Instructions). Set JP3 to the position as shown, if zones 7 or 8 are to be used.

The GEM-P1632 can use conventional 12 VDC 4-wire smoke detectors. To use them, the select fire zone programming option and do not select 2-wire smoke detector programming option for the desired fire zone (refer to the GEM-P1632 Programming Instructions). Set JP3 to the position as shown, if zones 7 or 8 are to be used.

Four wire smoke detectors may be connected to any programmed fire zone (1-8) as shown, within the panel. If the Zone Doubling is used (see EZ Zone Doubling Configuration), the respective complementary zones (9-16) are disabled when 4-wire smoke detectors are connected to zones 1-8. If external EZMs are used for zones 9-32, then 4-wire smoke detectors may be connected to any programmed fire zones (9-32).

Power must be obtained from terminal 25 and 6. If Fire Alarm Verification is desired to reset the smoke detectors, select this option for the desired fire zone.

# 2-WIRE SMOKE DETECTORS

2-WIRE SMOKE DETECTOR WIRING

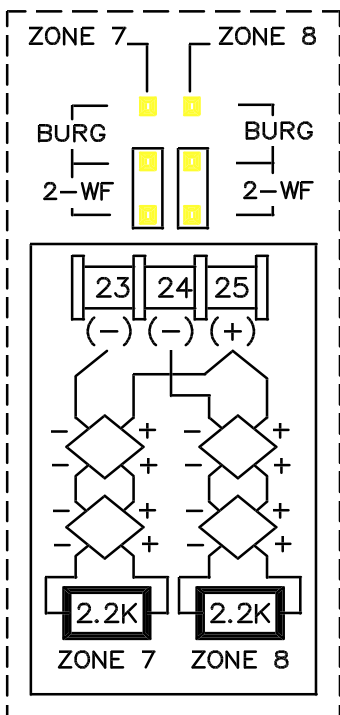

Two-wire smoke detectors can only be connected to zones 7 and 8. To use them, select fire zone programming option and select 2-wire smoke detector programming option for the desired fire zone 7 or 8 (refer to the GEM-P1632 Programming Instructions) and set JP3 to the position as shown. Connect the 2-wire smoke detectors as shown.

If the Zone Doubling is used (see EZ Zone Doubling Configuration), the respective complementary zones (15 & 16) are disabled when 2-wire smoke detectors are connected to zones 7 & 8.

If Fire Alarm Verification is desired to reset the smoke detectors, select this option for the desired fire zone (zone 7 or 8).

WIRING CONNECTIONS

# TELEPHONE LINES

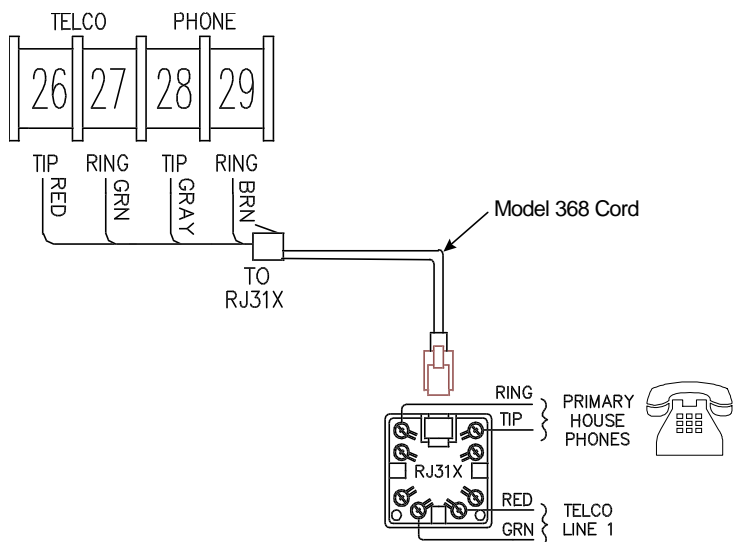

Connect the Model 368 Cord as follows: 26 (RED = Telco Tip), 27 (GREEN = Telco Ring), 28 (GRAY = Home Tip) and 29 (BROWN = Home Ring). Insert the modular plug into an approved USOCRJ31X jack (or a CA31A jack for Canadian installations). The Telco Line is used by the control panel to dial the central station and for downloading. This line should not be connected to party lines or coin operated telephones. If connected to a line with call waiting, then call waiting interrupt numbers must be programmed into the CS Telephone Numbers (refer to the GEM-P1632 Programming Instructions).

**WIRING CONNECTIONS**

# KEYPAD CONFIGURATION MODE

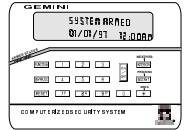

This section will focus on configuring the GEM-RP1CAe2 and GEM-RP2ASe2 Keypads. If there is more than one keypad in the system, *only Keypad No. 1 may be used for programming.*

## KEYPAD INSTALLATION

Two types of keypads may be used with the GEM-P1632: the GEM-RP1CAe2 and the GEM-RP2ASe2. Each must be assigned an address number (1–7) and each requires its own configuration procedure (see CONFIGURING THE KEYPADS, which follows, and DIRECT ADDRESS KEYPAD AREA OPTIONS). At least 1 keypad must be used; only 1 is required for a single-area Commercial Burglary installation.

**GEM-RP1CAe2** - is a 2-line combination fire/burglary/access keypad capable of supporting 4 EZM zones and a PGM output. A GEM-RP1CAe2 is recommended for use as Keypad #1.

**GEM-RP2ASe2** - is a utility LCD keypad combining several preset LCD words with a limited message line. **NOTE:** Due to space constraints, available messages are abbreviated and will scroll automatically.

## CONFIGURING THE KEYPADS

A total of up to 7 keypads may be connected to the panel. GEM-RP1CAe2 and GEM-RP2ASe2 keypads may be intermixed but require different configuration procedures, as described in the following paragraphs.

### Configuring the GEM-RP1CAe2 Keypad

Each GEM-RP1CAe2 keypad must be configured for (a) keypad tactile beep; (b) entry sounder; (c) keypad address; (d) compatibility number; (e) EZM address; and (f) zone response.

#### To enter the GEM-RP1CAe2 Configuration Mode:

1. Move jumper JP1 (located at the upper-right corner of the control panel board) from Pins 1-2 (top two) to Pins 2-3 (bottom two). **NOTE:** See Wiring Diagram on page 33.
2. After about 15 seconds, the display will read "XX OUT OF SYSTEM", where XX indicates the keypad address.
3. Press       and proceed as follows. (Repeat the following procedure for all keypads.)

**NORMAL  
KEYPAD  
CONFIGURE**

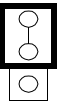

KEYPAD BEEP ON

### Keypad Tactile Beep

Upon entering the Keypad Configuration Mode, "KEYPAD BEEP ON" will be displayed, indicating that the tactile beep, which sounds when any button is pressed, is on. To turn off the tactile beep, press the  button (the  button will toggle the tactile beep on and off). Press the  button to continue or press the  button to exit.

### Entry Sounder

ENTRY SOUNDER ON

To turn off the keypad sounder during entry time, press the  button (the  button will toggle the tactile beep on and off). Press the  button to continue or press the  button to exit.

### Keypad Address

KEYPAD ADDRESS 01

If more than one keypad is installed, each must be assigned a unique keypad address (that is, no two keypads may be numbered alike):

- ☞ keypads must be numbered consecutively (missing numbers are not permitted)
- ☞ only Keypad No. 1 may be used for programming.



To assign the keypad number, proceed as follows:

1. Enter the assigned keypad number 01–07, then press the  button to save. A valid number will be acknowledged by a short beep; an invalid number will be rejected by a long beep.
2. Press the  button to continue or press the  button to exit.

NEW COMPAT# 0000

**Compatibility Number (Not Applicable)**



THIS FEATURE IS NOT COMPATIBLE WITH THE GEM-P1632 CONTROL PANEL.

Press the  button to continue or press the  button to exit.

EZM ADDRESS 01

**EZM Address**

The keypad's internal EZM (Expansion Zone Module) may be utilized to provide four additional wired zones. Whether used alone or in conjunction with optional GEM-EZM series modules or other keypad EZMs, it must be assigned a unique address (or Group number, see Keypad Programming Workbook) similar to its keypad address. If no other EZMs are to be used,

designate the keypad as Group "01" at the "EZM ADDRESS 00" display. In multiple-EZM systems, enter an assigned group number "01" through "06". (Each EZM must have a unique assigned group number, starting with "01" and proceeding consecutively.) Press the  button to continue or press the  button to exit.

ZONE RESPONSE 00

**Zone Response**

The normal loop response of each keypad expansion zone is 750mS, however the response time of any zone can be reduced to 50mS as follows.

1. Of the following, circle the number(s) in parentheses associated with the zone(s) to be changed:

Zone 1=(1); Zone 2=(2); Zone 3=(4); Zone 4=(8)

2. Add up the circled numbers.



3. At the keypad, enter the sum as a two-digit number "01" through "15" on the display, then press the  button.

**Example.** Change Zones 2, 3 and 4 to 50mS response.

1. Circle numbers for Zones 2, 3 and 4: (2), (4) and (8).

2. Add up the circled numbers: 2 + 4 + 8 = 14.



3. Enter "14" at the keypad, then press the  button.

Press the  button to continue or press the  button to exit.

**Program Control Message (Not Applicable)**

PROG CTRL MSG# 1

THIS FEATURE IS NOT COMPATIBLE WITH THE GEM-P1632 CONTROL PANEL.

Press the  button to continue (the display will loop back through selections, for changes) or press the  button to exit the Keypad Configuration Mode (display will read "01 OUT OF SYSTEM"). Then replace Jumper JP5 across Pins 1–2 (top two).

### Configuring the GEM-RP2ASe2 Keypad

Up to 7 GEM-RP2ASe2 keypads may be connected to the panel (Keypads 1–7). Each must be configured for a keypad address. In addition, the keypad may be configured to disable (a) touchpad backlight; (b) LCD backlight; and (c) entry sounder. Keypads are configured by the proper selection of jumpers. Refer to the label on the circuit board fishpaper (LA1390) for jumper locations and a summary of settings.

KEYPAD NUMBER	KEYPAD NUMBER			PARK
	1	2	3	
1	OFF or ON*	OFF	OFF	STORE SPARE JUMPER AT THIS POSITION
2	OFF	ON	OFF	
3	ON	ON	OFF	
4	OFF	OFF	OFF	
5	ON	OFF	ON	
6	OFF	ON	ON	
7	ON	ON	ON	

#### KEYPAD ADDRESS

If more than one keypad is installed:

☞ Each must be assigned a unique address (that is, no two keypads may be numbered alike).

☞ Keypads must be addressed consecutively (that is, missing numbers are not permitted).

☞ Only Keypad No. 1 may be used for programming. (However, for ease of programming, it is recommended that a GEM-RP1CAe2 be selected as Keypad #1.)

Assign the keypad address number by selecting Jumpers J1–3 in accordance with the table at left.

**\*Note:** (1) Keypads are factory supplied with no jumpers installed and as such are automatically configured as Keypad No. 1. (2) Only one keypad in the system may be configured as Keypad No. 1, otherwise none will function.

tion.

#### TOUCHPAD BACK LIGHT

Cut Jumper A to disable touch pad backlighting to conserve 11mA standby current.

#### LCD BACKLIGHT

Cut Jumper B to disable LCD backlighting.

#### DISABLE SOUNDER

Cut Jumper C to disable the sounder. (Do not disable in UL applications.)

KEYPAD CONFIGURATION



**NAPCO Security Systems, Inc.**  
 333 Bayview Avenue, Amityville, New York 11701  
 For Sales and Repairs, call toll free: (800) 645-9445  
 For direct line to Technical Service, call toll free: (800) 645-9440  
 Internet: <http://www.napcosecurity.com>

# BASIC OPERATION

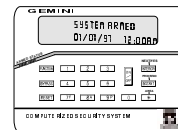

This section provides a brief overview of system operation. For detailed operation, refer to the User's Guide furnished with the keypad (OI234 for the GEM-RP1CAe2; OI192 for the GEM-RP2ASe2) and to the Keypad Programming Modes at the end of this manual. **NOTE:** Keypad displays shown in this text are for the GEM-RP1CAe2 keypad. GEM-RP2ASe2 displays will be similar, although abbreviated, and will scroll automatically.

## USER CODES & ZONE DESCRIPTIONS

(Refer to the GEM-P1632 Programming Instructions (WI897) for a detailed explanation of programming.) Up to 32 personal user codes may be programmed at the keypad. **NOTE:** The Area Options associated with each User Code may only be programmed in the Dealer Program Mode.

### **Default User Code.**

The first code programmed should replace the default (User 01) code, "U01 123 ••• - ••• - ••", (1,2,3), which should not be selected as a user code.

Each user should be assigned his own dissimilar code and should be cautioned against divulging his code to anyone else. Thus should it become necessary to remove a user from the system, that one code may be cancelled without affecting other codes, and that user would then be prevented from entry. **NOTE:** Napco's PCD3000 Quickloader Software provides enabling and disabling User Codes at programmed times using the scheduling menus. Ambush code should not contain digits used as the first digits of any user code.

### **Changing or Canceling a Code**

To change any code, merely program over the existing code as described in the Programming Instructions. Similarly, to cancel a code, blank out each number of the code.

### **Arm/Disarm Code (Programmable in Dealer Program Mode only)**

An Arm/Disarm Code may be used to arm/disarm the area in which it is programmed. Up to 6 digits may be programmed or it may be programmed as a two-digit code for the purposes of quick arming.

### **Arm-Only Code (Programmable in Dealer Program Mode only)**

An Arm-Only Code may only be used to arm the area in which it is programmed; it never has any disarm capability. Up to 6 digits may be programmed or it may be programmed as a two-digit code for the purposes of quick arming.

### **Service Code (Programmable in Dealer Program Mode only)**

A Service Code is an Arm/Disarm Code that is easily activated when needed, and dormant at other times. Intended for the occasional or temporary user (maid, repairman, etc.) who would otherwise be denied access to the premises. It is activated by arming with it; an "S" will appear in the display (GEM-RP1CAe2 only) after the exit-delay countdown, indicating that a Service Code has been activated. It may then be used to arm and disarm just as any other User Code. Service code can be armed/disarmed from a disarmed state, but it cannot be armed/disarmed from an armed state, after another user code has been entered.

### **Access Code**



The Access Code will trip the panel's PGM2 Output Relay while disarmed if "Access Control on PGM2 Output" and "PGM2 Output Access Control Time" is programmed. The Access Code is programmed as any other User Code but without arm/disarm capability. *Caution:* Do not use the same code as any Arm/Disarm Code. Note: These systems have not been investigated by UL for compliance with UL294 (Access Control Systems).





### **Ambush Code**





The Ambush Code is a two-digit code entered by the user just prior to disarming, typically to cause a silent report to be sent to the central station. Thus, should the user be forced to disarm by an assailant, he can silently signal an emergency while appearing to be merely disarming the panel. (Check the glossary for programming required to enable this feature.) Ambush Code should not contain digits used as the first two digits of any user code.



### **Zone Descriptions. (GEM-RP1CAe2 only.)**

Zone descriptions follow the Program Code in the normal programming sequence ("01-" will appear in the display). Program the description, up to two lines, letter by letter. Buttons  and  control the position of the cursor.

Buttons  will clear the entry at the cursor. When programming zone descriptions, buttons  and  will scroll not only through numbers 0-9, but through the alphabet and a series of punctuation marks and symbols as well. (Roughly note the order in which the letters, numbers and symbols are displayed so that you will be able to determine the proper direction to scroll, up or down, for fastest access. As familiarity improves, so will programming speed.) When the description has been entered and is satisfactory as displayed (e.g. "GARAGE"), press the  button to save it in memory.

To advance to the next zone (or to any other zone, for that matter), position the cursor over the displayed Zone Number, i.e., "01" using buttons  and . Change the Zone Number using buttons  and . Repeat the zone-description programming procedure for the new zone. Advance to the next zone and repeat until all zones (up to 32) have been programmed.

## **ARMING AND DISARMING THE SYSTEM**



In the normal disarmed state, only the green STATUS LED will be on and the display will read "SYSTEM READY". To silence an alarm, enter any User Code, then press the  button. Any valid User Code may be used to arm or disarm; an Arm-Only Code may only be used to arm.

### **Arming**

 To arm, **enter a valid User Code, then press the  button.**

(If a wrong code is entered, the keypad will display "INVALID ENTRY / TRY AGAIN".) The green STATUS LED will go off, the red ARMED LED will go on, and the display will read "EXIT TIME XXX" ("XXX" representing the programmed exit-delay time, in seconds). The exit delay will immediately start counting down toward "000", in 10-second decrements, indicating the available time remaining to exit through an exit/entry door.

#### **Note:**

-  1. (GEM-RP1CAe2 only.) An "S" in the display (e.g. "EXIT TIME XXX S") will appear as a reminder that the system is being armed with the Service Code active. (To turn off the Service Code, disarm, then rearm using a regular Arm/Disarm Code.)
-  2. If the System Trouble is displayed, there should be an attempt to correct the system trouble (for example by calling an alarm maintenance or an alarm repairman). If this cannot be done, then press the  button to allow 5 minutes to access the keypad without the system trouble displayed. Immediate attention should be provided, when system troubles are encountered.

### **Disarming**

When the exit time has elapsed, the display will read "SYSTEM ARMED". This indicates that upon entering the premises through an exit/entry door, there will be an entry delay to allow time to disarm the panel. The GEM-RP1CAe2 display will read "ENTRY TIME XXX" ("XXX" representing the programmed entry-delay time, in seconds). The sounder will come on and the entry delay will immediately start counting down toward "000" in intervals of 10 seconds, indicating the available time remaining to disarm the panel. The sounder will pulse during the final 10 seconds.

 To disarm the panel, **enter a valid User Code, then press the  button.**

## Arming with No Delay

 Press the  button prior to or after arming.

This feature allows normal exit delay, but cancels the next entry delay through an entry/exit zone. The display red LED will flicker. This feature may be used to provide instant protection while you or someone else is still on the premises. It will be cancelled automatically upon disarming.











## Priority Arming

A 2-second tone and "ZONE NOT NORMAL/CAN'T ARM" displayed when attempting to arm indicates a priority condition; that is, a problem exists on at least one zone that has been designated a Priority Zone, or a system trouble exists. The trouble(s) must be corrected before the panel can be armed. The display will read "ZONE FAULTS", then automatically scroll through all unsecured zones. If a system trouble is indicated, display the system trouble.

## Area Arming/Manager's Mode

In a partitioned system, either or both secured areas may be armed (or disarmed) from the Manager's Mode (if enabled). The Manager's Mode, is a low-security mode of operation. It provides quick access to other areas without the system status display.



### To arm or disarm the alternate area:

-  1. Press the  or  button representing the alternate area.
-  2. Press the  button, then the  button. The keypad will display "SYSTEM READY X", where "X" denotes the area selected. In effect, you will now be in that area.
-  3. Arm or disarm the area using your code (the code must be valid in that area).
-  4. To return the keypad to its "home" area, the  button, then the  button.

**Note:** If the "home" keypad has been changed to the alternate area and unused for more than 5 minutes, it will revert to the home area.

## BYPASSING ZONES

### *Bypassing Interior Zones*





Interior zones allow perimeter zones to be armed while part or all of the active interior remains disarmed. When the  button is pressed, the "BYPASSED" reminder will come on. Pressing the  button within 10 seconds will bypass the selected interior group without arming, otherwise Interior Bypass will time out and the system will revert to the regular disarmed state. All zones designated for the selected interior group(s) will be bypassed simultaneously when the system is armed.

## ALARM INDICATION

 To silence an alarm, enter a valid User Code, then press the  button.



Should a burglary alarm occur, the red ARMED LED will flash, and the display will alternately read "ALARM", then the zones violated. Disarm the panel; the display will read "ALARM" and will continue to indicate the violated zones until the  button is pressed or the panel is armed once again.

## FUNCTION MODE/DEALER PROGRAM MODE

The keypad can provide a wide assortment of utility functions as summarized in the Keypad Programming Modes. The functions are displayed in a prompting "YES/NO" format. To skip a function, answer NO (press the  button); to select and execute a function, answer YES (press the  button or the  button). The complete function list is provided here in its normal displayed sequence. However, since not all functions are designed for all systems (or intended for all users), only functions that are applicable and active are displayed. (For example, if no zones are bypassed, "DISPLAY ZN BYPASSED" will not appear.) Furthermore, functions that are intended for use by the installer or servicer will not be displayed. **Note:** Functions may be manually scrolled forward or backward using the  and the  buttons, respectively.

To return to normal keypad operation, press the  button. (The keypad will automatically return to its normal operating mode if no activity is detected for longer than one minute.)

**Note:** (1) In all UL-listed applications and in high-security installations, only those users having valid codes can access the Function Mode. (2) Due to space constraints, GEM-RP2ASe2 message displays are abbreviated.

**Remember:** (1) Functions that are not active, not programmed and/or not applicable to the user's authority level will be suppressed and will not display. (2) Press NO ( button) to skip a function; press YES ( button) to execute it. (3) The GEM-RP2ASe2 displays abbreviated messages that autoscroll.

### **ACTIVATE BELL TEST**

Press YES ( button) to activate the burg relay output (while disarmed) for about 2 seconds. If the device does not sound, it may be defective.

### **ACTIVATE CHIME**

Press YES ( button) to sound a tone at the keypad when a Chime Zone is violated. The duration of the tone is programmable. To turn off the Chime Mode, press YES ( button) at the DEACTIVATE CHIME function.

### **ACTIVATE FAULT FIND**

This troubleshooting aid will help the installer locate swingers. When accessed, two things occur:

- ✓ The loop response of each zone is set for the fastest response time.
- ✓ Causing or repairing a fault activates the sounder for about 7 seconds.

Tapping and poking at suspect points, the installer can easily locate swingers by listening for the beep. This eliminates the need of returning to the keypad to visually check after each attempt. Pressing the  button to restore normal operation. Arming the system automatically cancels the Fault find Mode. **Note:** When testing wireless systems, the keypad will not beep if the signal strength is less than 3, but the strength will still be displayed.

**TO ARM IN 1-4 HRS. (Not for UL Installations.)**

Use this function to (a) delay programmed autoarming up to 4 hours, 15 minutes or (b) initiate autoarming in 4 hours, 15 minutes as follows. **Note:** Autoarming may not be used in UL installations.

At the "AUTOARM IN 1-4HR" display:

For 1hr, 15min delay: press the  button, then the  button.

For 2hr, 15min delay: press the  button, then the  button.

For 3hr, 15min delay: press the  button, then the  button.

For 4hr, 15min delay: press the  button, then the  button.

Fifteen minutes prior to arming, the siren will sound a 2-second warning and the keypad will begin a 15-minute countdown with the sounder pulsing. (The sounder may be silenced by pressing the  button, but it will come back on one minute before arming.) Within this countdown window, arming may be delayed an additional 1 to 4 hours, as above, or autoarming may be cancelled by arming and disarming the panel.

**ACTIVATE PROGRAM**

At Keypad No. 1, press YES (the  button) to activate the User Program (Program-1) Mode or Dealer Program (Program-2) Mode, depending upon the code entered. Scroll through the programmable functions using NEXT (the  button) and PRIOR (the  button). **Note:** Keypad No. 1 may be located in any area.

**ACTIVATE DOWNLOAD**

Used on-site for remote downloading of a control-panel program from the PCD3000. Press YES (the  button) to initiate the data transfer.



## KEYPAD MESSAGES

The GEM-RP1CAe2 Keypad can display the following messages. The GEM-RP2ASe2 will display similar abbreviated messages that may scroll through two screens. **Note:** Refer to OI234 for the GEM-RP1CAe2 Keypad; OI192 for the GEM-RP2ASe2 Keypad.

**SYSTEM READY CW** - All zones operating; system can be armed. GEM-RP1CAe2 only: C = Chime Mode on; W = Watch Mode on; 1 through 2 = Area.

**PLEASE WAIT** - Panel reporting to central station on arming. Wait for ringback signal to exit.

**EXIT TIME XXX** - Exit delay in progress. XXX = exit time remaining in 10-second decrements; GEM-RP1CAe2 only: S = Service Code active; I = arming with Instant protection.

**ENTRY TIME XXX** - Entry delay in progress. XXX = entry time remaining in 10-second decrements.

**SYSTEM ARMED** - Panel armed. GEM-RP1CAe2 only.

**ZONE FAULTS** - One or more zones not secured. Display status for zone description(s). GEM-RP1CAe2 only.

**CAN'T ARM/ZONES NOT NORMAL** - Arming attempted with Priority Zone in trouble. Secure zone to arm.

**DAY ZONE TRBL** - Trouble condition on Day Zone, followed by one or more zone descriptions.

**INVALID ENTRY/TRY AGAIN** - Wrong code/time/area number entered.

**CAN'T ARM SYSTEM/PRESS RESET** - Arming attempted with System Trouble present. Press the **RESET** button and then arm the system.

**ALARM** - Alarm condition, followed by one or more zone descriptions.

**\*\*\*\*FIRE\*\*\*\*** - Fire alarm condition, followed by one or more zone descriptions.

**FIRE TROUBLE** - Trouble condition on a Fire Zone. Press **RESET** button to silence the sounder. Correct the trouble, then press the **RESET** button again.

**FIRE ALARM** - Alarm condition on a Fire Zone. Press the **RESET** button to silence the sounder. Correct the cause of the alarm, then press the **RESET** button again.

**ZONES BYPASSED** - (When Zones Bypassed displayed) Indicates zones that have been deactivated.

**OV(R-)** - Overview Mode (Status of 2 areas): R=Zone Ready; also, Z=Zone Fault; A=Armed; B=Burglary Output; F=Fire Alarm; T=Fire Trouble; C=Check Trouble; Display Mode.

**SYSTEM TROUBLE** - A System Trouble display will be followed by one or more of the following error codes:

**E01-00 - AC POWER FAIL.** Power failure. Check power transformer. Check for blown fuse or circuit breaker; general power outage.

**E02-00 - LOW BATTERY.** Battery below 11 volts. If not recharged within 24 hours, replace it.

**E03-00 - COMM FAIL.** Unsuccessful communication to central station. **Note:** Will also display if panel improperly programmed to report; i.e., Report Alarm, Report Codes, Subscriber ID Numbers, etc. must be programmed.

**E04-NN - WL TRBL.** Wireless transmitter supervisory failure. NN = transmitter number.

**E05-NN - WL LOBATT.** Rf transmitter low battery. NN = transmitter number.

**E06-NN - RF REC TROUBLE.** Rf receiver response trouble. NN = receiver number.

**E07-00 - DOWNLOAD FAIL.** Download failure.

**E08-00 - TELCO LINE1 FAIL.** Telephone line failure (system trouble displays after a programmed delay).

**E09-00 - NOT PROGRAMMED.** System cold start.

**E10-NN - BURG KEYPAD TRBL.** Keypad response failure. NN = keypad number.

**E11-NN - BURG KPD TAMPER.** Keypad cover removed. NN = keypad number.

**E12-NN - BURG EZM TRBL.** Expansion zone module failure. NN = module number.

**E13-NN - BURG EZM TAMPER.** EZM module cover removed. NN = module number.

**E14-NN - RELAY BOARD TRBL.** Relay board response failure. NN = relay board number.

**E15-NN - WL TAMPER.** Transmitter cover removed. NN = transmitter number.

**E16-NN - RF REC JAMMED.** Receiver jammed. NN = receiver number.

**E17-NN - RF REC TAMPER.** Receiver cover removed. NN = receiver number.

**E18-NN - LOBATT KEYFOB.** Key fob transmitter low battery. NN = key fob transmitter number.

**E19-00 - USER MEM ERROR.** Internal memory error. Select RESET SYSTEM TBL. Press the **ON OFF** button, then the **RESET** button.

**E20-00 - DEALER MEM ERROR.** Same as above.

**E22-NN - PIR SENSOR TRBL.** No trip detected on PIR Supervision Zone within programmed Sensor-Watch time. NN = Zone number. To reset, press YES (**INTERIOR**) button at "RESET SENSOR MSG" function display.

**E23-00 - BURG BUS FAILED.** Failure of 4-wire bus. Check Terminals 11/12.

**E24-00 - TIME FOR SERVICE.** A service message can be programmed through the PCD3000 Quickloader (event-schedule screen) to remind the user to arrange for scheduled maintenance. At the programmed date and time, the keypad sounder will start to pulse and the display will read "TIME FOR SERVICE" (GEM-RP1CAe2) or "SERV" (GEM-RP2ASe2). This condition will behave as a system trouble and may be cleared as such, i.e., press the **RESET** button to silence sounder; access RESET SYSTEM TRBL, then press the **ON OFF** button.

**E39-00 - RF CAPACITY TRBL.** Receiver capacity error.

**E51-00** - Alarm Output Supervisory.

**E99-00** - Keypad panic shorted too long. GEM-RP2ASe2 only.

**NN OUT OF SYSTEM** - Keypad inoperative. NN = keypad number.

**ALARM** - (After panel is disarmed) displays zones violated.

**FAULT FIND** - Fault-find Mode activated.



# STANDBY-BATTERY CALCULATION WORKSHEET

STANDBY-BATTERY CALCULATION WORKSHEET

Use the procedure given below to determine the required standby battery capacity in Ampere-Hours (AH). NOTE: It is not totally accurate to merely multiply the combined standby current (in amperes) by the standby time (in hours) to obtain the battery capacity (in ampere-hours), since other factors (control-panel charging capabilities, temperature, battery condition, etc.) affect battery operation. The following calculations will yield the theoretical minimum required capacity.

## 1. STANDBY CURRENT

DEVICE	QTY		STANDBY CURRENT (Amps)		
			EACH	=	TOTAL
GEM-P1632	1	X	0.120	=	
GM-EZM816		X	0.050	=	
GEM-RP1CAe2		X	0.100	=	
GEM-RP1CAe2 <sup>(1)</sup>		X	0.035	=	
GEM-RP2ASe2		X	0.065	=	
GEM-RP2ASe2 <sup>(2)</sup>		X	0.020	=	
RM3008 <sup>(3)</sup>		X	0.040	=	
		X		=	
		X		=	
<b>TOTAL STANDBY CURRENT</b> →					<b>Amperes</b>

$$\text{[Box 1]} \text{ Amps} \times \text{[Box 2]} \text{ (Standby Time)}^{(4)} = \text{[Box 3]} \text{ AH.}$$

- <sup>(1)</sup> Backlighting disabled (cut Jumpers W1, W2 & W3). (Box 1)
- <sup>(2)</sup> Backlighting disabled (cut Jumpers A, B & C).
- <sup>(3)</sup> Add 0.010A for each energized relay.
- <sup>(4)</sup> Standby Time in Hours.

## 2. ALARM CURRENT

DEVICE	QTY		ALARM CURRENT (Amps)		
			EACH	=	TOTAL
<b>TOTAL STANDBY CURRENT</b> (from Box 1, above) →					
GEM-P1632 <sup>(1)</sup>		X	0.100	=	0.100
BELLS		X		=	
STROBES		X		=	
HORNS / STROBES		X		=	
		X		=	
		X		=	
<b>TOTAL ALARM CURRENT</b> →					<b>Amperes</b>

$$\text{[Box 1]} \text{ Amps} \times \text{[Box 2]} \text{ (Alarm Time)}^{(2)} = \text{[Box 3]} \text{ AH.}$$

- <sup>(1)</sup> Alarm current drawn in alarm.
- <sup>(2)</sup> Alarm Time in Hours. Example: For a 15 minute alarm timeout, Alarm Time = 15/60 = 0.25.

$$\text{MINIMUM REQUIRED BATTERY CAPACITY} = \text{BOX 2} + \text{BOX 3} \rightarrow \text{[Box 4]} \text{ AH.}$$

# WIRING LEGEND

Should removal of the circuit board be necessary, use this wiring legend to relocate wire leads to their proper terminals. Enter wire identification number or color code in WIRE NUMBER column and enter wire function in DESCRIPTION column (optional).

WIRING LEGEND

TERMINAL	WIRE NO.	DESCRIPTION
1		
2		
3		
4		
5		
6		
7		
8		
9		
10		
11		
12		
13		
14		
15		
16		
17		
18		
19		
20		
21		
22		
23		
24		
25		
26		
27		
28		
29		

# KEYPAD PROGRAMMING MODES

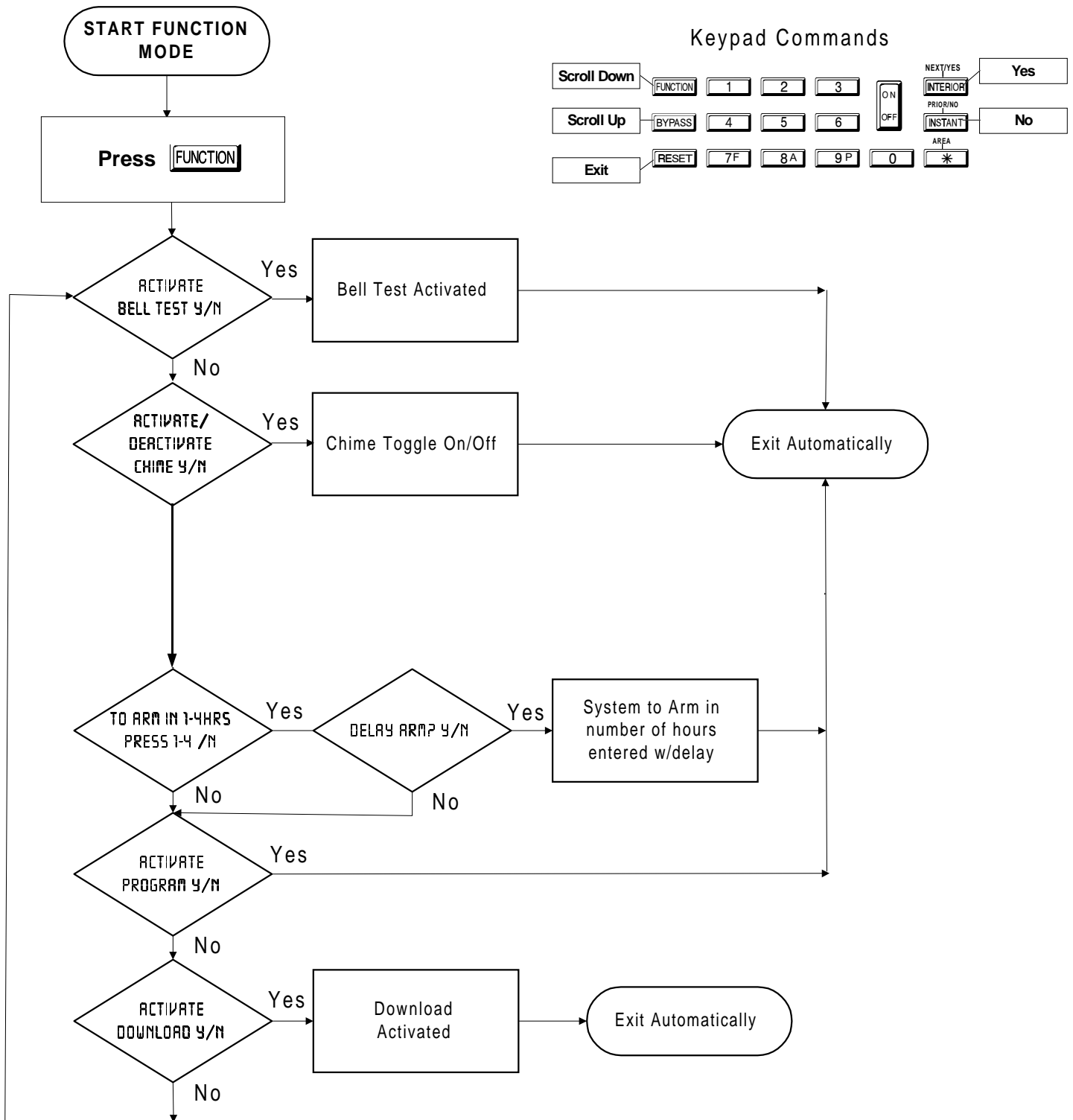

KEYPAD PROGRAMMING MODES

**START DEALER PROGRAM MODE**

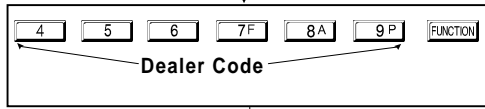

**Keypad Commands**

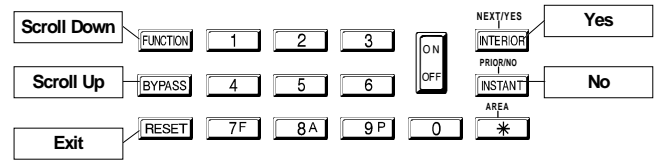

**KEYPAD PROGRAMMING MODES**

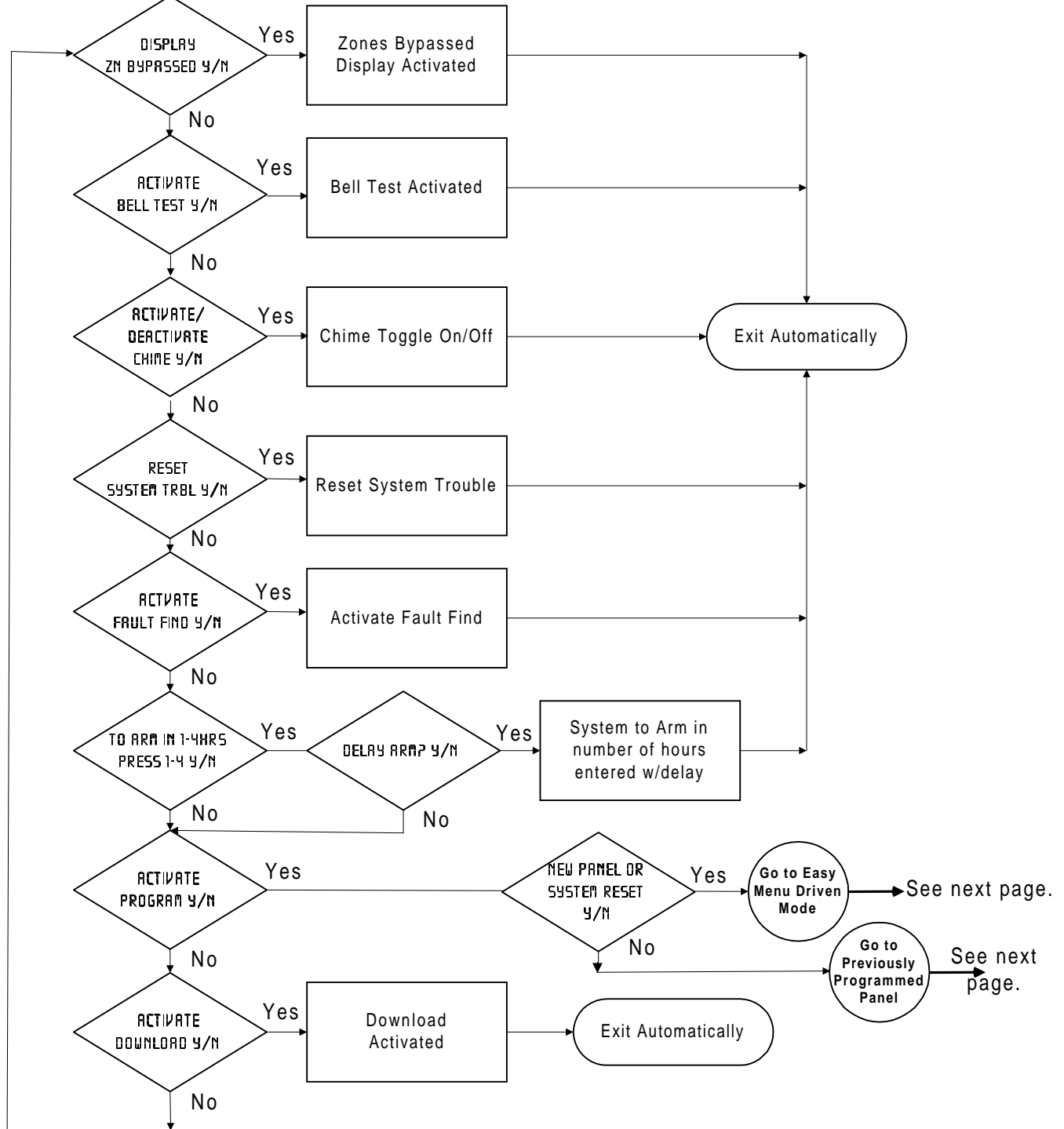

**Easy Menu Driven Mode**

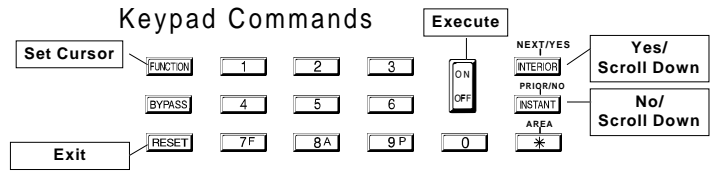

Enter # of Zones in Area 1

EZ ZONE DOUBLING ENABLED? Y/N

Yes

No

Enter Fire Zone Numbers in Area 1

Enter 2-Wire Fire Zone Numbers in Area 1

REPORT ALL ZONES TO CENTRAL? Y/N

Yes

No

Enter Entry/Exit Zone Numbers in Area 1

Enter Interior Zone Numbers in Area 1

Enter Number of Keypads in Area 1

Enter Central Station 1 Telephone Number

Previously Programmed Panel

Enter CS Receiver 1 Account Number

Enter CS Receiver 1 Format

Enter User Codes for both Areas

Enter RF Xmitter to Zone Mapping

Enter Keypad Area Mapping

Enter Zone Descriptions

Enter Dealer Code

Press **RESET** (at any time)

Go to Direct Address Mode

Press **RESET** (again)

EXIT

**KEYPAD PROGRAMMING MODES**

**START USER PROGRAM MODE**

1 2 3 FUNCTION  
 New Panel: Default User Code (123)  
 Existing Panel: Any Code with User Program Option Enabled

**Keypad Commands**

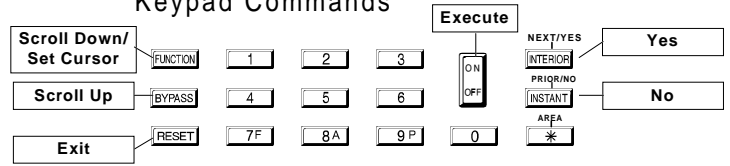

**KEYPAD PROGRAMMING MODES**

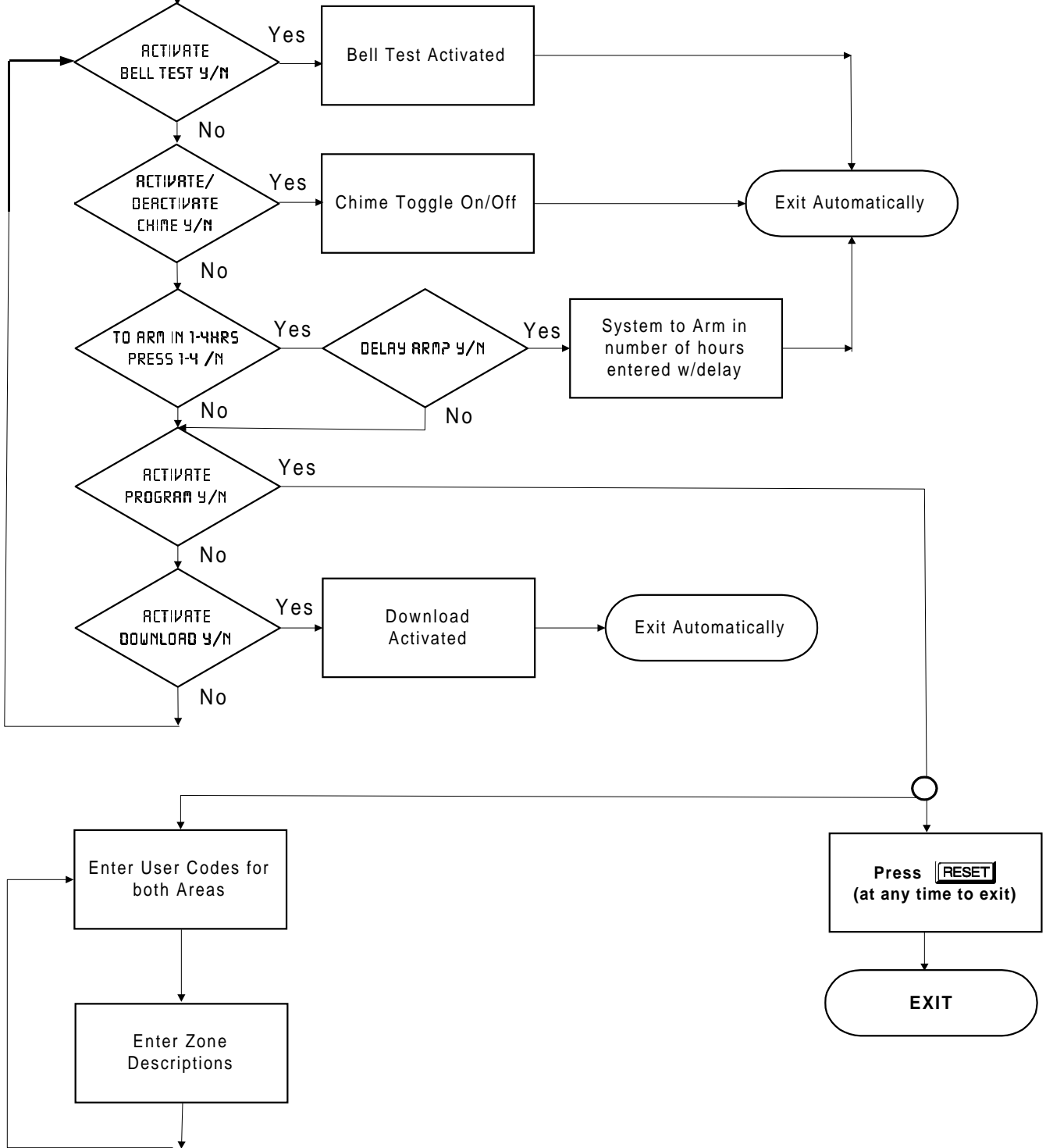



NAPCO SECURITY SYSTEMS, INC. AMITYVILLE, N.Y. 11701

# GEM-P1632 WIRING DIAGRAM

(REFER TO OPERATION AND INSTALLATION INSTRUCTIONS W1808) RESIDENTIAL AND COMMERCIAL BURGLARY \*\*

16.5V TRANSFORMER	STANDBY BATTERY	COMBINED STANDBY CURRENT	ALARM CURRENT	STANDBY CURRENT TIME
40VA/50VA	7AH	650mA	2.0A	4 HOURS
20VA*	4AH	500mA	2.0A	4 HOURS
20VA*	7AH	500mA	2.0A	6 HOURS

This equipment should be installed in accordance with Chapter 2 of the National Fire Alarm Code, ANSI/NFPA 72-1996 (National Fire Protection Association Batterymarch Park, Quincy, MA 02269), and local codes. Information describing proper installation, operation, testing, maintenance, evacuation planning, and repair service is to be provided with this equipment. UL Listed Limited Energy Cable is required.

16.5V TRANSFORMER	STANDBY BATTERY	COMBINED STANDBY CURRENT	ALARM CURRENT	STANDBY TIME
40VA/50VA	7AH	120mA	520mA(1)	24 HOURS
40VA/50VA*	2-7AH	360mA	280mA(1)	24 HOURS
20VA*	7AH	120mA	360mA(1)	24 HOURS
20VA*	2-7AH	360mA	120mA(1)	24 HOURS

(1) ALARM CURRENT CAN BE INCREASED BY REDUCING STANDBY CURRENT BY THE SAME AMOUNT.

\* NOT PRESENTLY EVALUATED BY U.L. \*\* COMMERCIAL BURGLARY IS NOT PRESENTLY EVALUATED BY U.L.

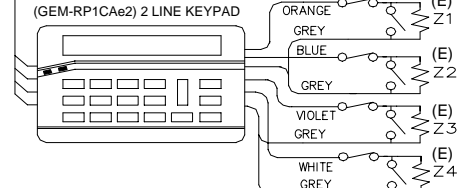
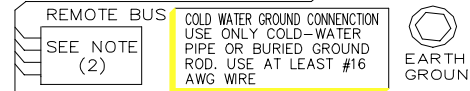
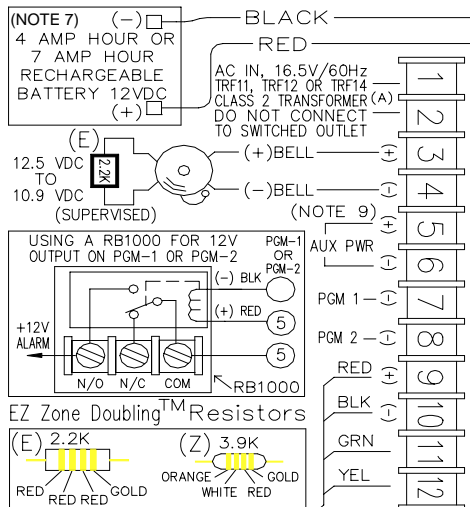

THIS UNIT INCLUDES AN ALARM VERIFICATION FEATURE THAT WILL RESULT IN A DELAY OF THE SYSTEM ALARM SIGNAL FROM THE INDICATED CIRCUITS. THE TOTAL DELAY (CONTROL UNIT PLUS SMOKE DETECTORS) SHALL NOT EXCEED 60 SECONDS. NO OTHER SMOKE DETECTORS SHALL BE CONNECTED TO THESE CIRCUITS UNLESS APPROVED BY THE LOCAL AUTHORITY HAVING JURISDICTION. CIRCUIT CONTROL UNIT SMOKE DETECTORS ZONES DELAY-SEC.

MODEL DELAY-SEC.

THE DELAY (POWER UP) (STARTUP) TIME MARKED ON THE INSTALLATION WIRING DIAGRAM OF THE SMOKE DETECTOR OR ON THE INSTALLED SMOKE DETECTOR(S) IS TO BE USED.

- NOTES:**
- 1.) ALARM CURRENT CAN BE INCREASED BY REDUCING STANDBY CURRENT BY THE SAME AMOUNT.
  - 2.) THE FOLLOWING DEVICES MAY BE PLACED ON THE REMOTE BUS: GEM-RP1Ca2, GEM-RP2Ase2, GEM-EZM816, GEM-X10, GEM-RECV8, GEM-RECV16, RM3008, GEM-EVA1 AND WIZARD2.
  - 3.) REFER TO W1808 FOR U.L. LISTINGS.
  - 4.) COMBINED STANDBY CURRENT = KEYPAD CURRENT + AUX CURRENT + FIRE POWER + PGM1 AND PGM2 CURRENT.
  - 5.) UNIT INTENDED TO BE MOUNTED VERTICAL ON WALL
  - 6.) REFER TO W1808 FOR COMPATIBLE TWO WIRE SMOKE DETECTORS. DO NOT MIX DIFFERENT MODELS.
  - 7.) RECOMMENDED BATTERIES YUASA NP4-12 OR NP7-12. BATTERY SHOULD BE REPLACED EVERY 5 YEARS.
  - 8.) THIS PANEL SHALL BE CHECKED BY A QUALIFIED TECHNICIAN AT LEAST ONCE EVERY 3 YEARS.
  - 9.) AUX. POWER AND FIRE POWER VOLTAGE RATING: 12.5 VDC TO 11.7 VDC.
  - 10.) A.C MUST BE DISCONNECTED WHEN PERFORMING WEEKLY TESTS.
  - 11.) THIS PANEL ONLY SUPPORTS ONE SMOKE DETECTOR IN ALARM FOR EACH ZONE.

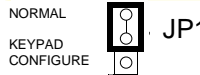
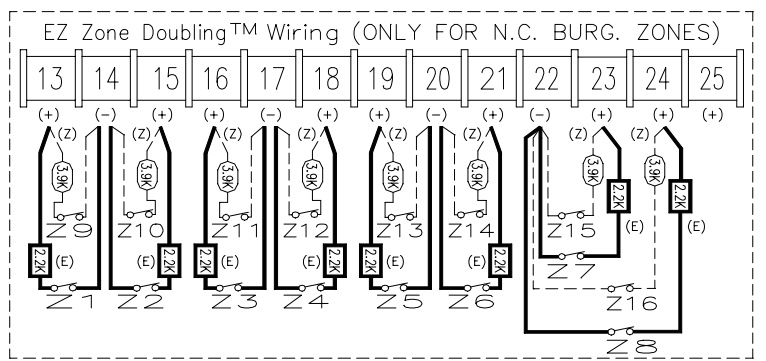
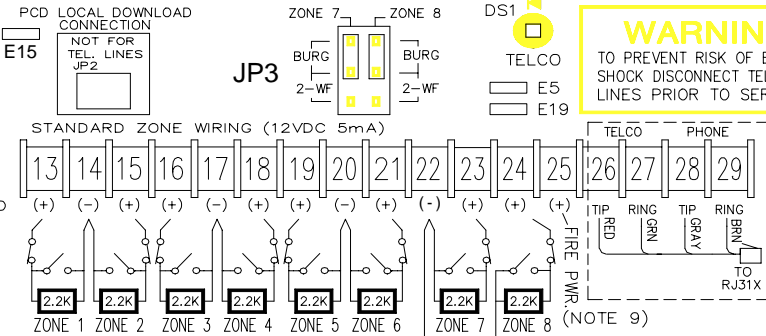

**WARNING**  
TO PREVENT RISK OF ELECTRIC SHOCK DISCONNECT TELEPHONE LINES PRIOR TO SERVICING.

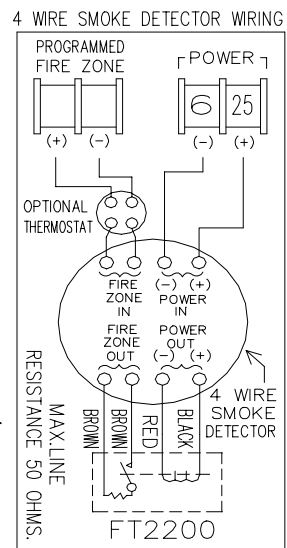
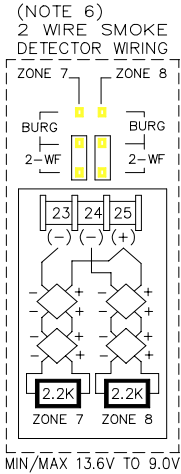

LA1469B

# NOTES

### FCC STATEMENT

This equipment generates and uses radio-frequency energy and, if not installed and used properly, that is, in strict accordance with the manufacturer's instructions, may cause interference to radio and television reception. It has been type tested and found to comply with the limits for a Class-B computing device in accordance with the specifications in Subpart J of Part 15 of FCC Rules, which are designed to provide reasonable protection against such interference in a residential installation.

However, there is no guarantee that interference will not occur in a particular installation. If this equipment does cause interference to radio or television reception, which can be determined by turning the equipment off and on, the user is encouraged to try to correct the interference by one or more of the following measures: reorient the receiving antenna; relocate the computer with respect to the receiver; move the computer away from the receiver; plug the computer into a different outlet so that computer and receiver are on different branch circuits.

If necessary, the user should consult the dealer or an experienced radio/television technician for additional suggestions. The user may find the following booklet prepared by the Federal Communications Commission helpful: "How to Identify and Resolve Radio-TV Interference Problems". This booklet is available from the U.S. Government Printing Office, Washington, DC 20402; Stock No. 004-000-00345-4.

**CAUTION:** This equipment generates and uses radio-frequency energy. If not installed using conventional installation practices for RF devices, it may cause interference to radio and television reception. It has been tested and found to comply with the limits for a Class A computing device pursuant to Subpart B of Part 15 of FCC Rules, which are designed to provide reasonable protection against such interference. However, there is no guarantee that interference will not occur in a particular installation. If it has been found to cause interference to radio or television reception, which can be determined by removing and reapplying AC and battery power to the equipment, the installer should try to correct the interference by one or more of the following measures: reorient the receiving antenna; connect the power transformer to a different outlet so that the control panel and receiver are on different branch circuits; relocate the control panel with respect to the receiver.



## NAPCO LIMITED WARRANTY

NAPCO SECURITY SYSTEMS, INC. (NAPCO) warrants its products to be free from manufacturing defects in materials and workmanship for *thirty-six months* following the date of manufacture. NAPCO will, within said period, at its option, repair or replace any product failing to operate correctly without charge to the original purchaser or user.

This warranty shall not apply to any equipment, or any part thereof, which has been repaired by others, improperly installed, improperly used, abused, altered, damaged, subjected to acts of God, or on which any serial numbers have been altered, defaced or removed. Seller will not be responsible for any dismantling or reinstallation charges.

THERE ARE NO WARRANTIES, EXPRESS OR IMPLIED, WHICH EXTEND BEYOND THE DESCRIPTION ON THE FACE HEREOF. THERE IS NO EXPRESS OR IMPLIED WARRANTY OF MERCHANTABILITY OR A WARRANTY OF FITNESS FOR A PARTICULAR PURPOSE. ADDITIONALLY, THIS WARRANTY IS IN LIEU OF ALL OTHER OBLIGATIONS OR LIABILITIES ON THE PART OF NAPCO.

Any action for breach of warranty, including but not limited to any implied warranty of merchantability, must be brought within the six months following the end of the warranty period.

IN NO CASE SHALL NAPCO BE LIABLE TO ANYONE FOR ANY CONSEQUENTIAL OR INCIDENTAL DAMAGES FOR BREACH OF THIS OR ANY OTHER WARRANTY, EXPRESS OR IMPLIED, EVEN IF THE LOSS OR DAMAGE IS CAUSED BY THE SELLER'S OWN NEGLIGENCE OR FAULT.

In case of defect, contact the security professional who installed and maintains your security system. In order to exercise the warranty, the product must be returned by the security professional, shipping costs prepaid and insured to NAPCO. After repair or replacement, NAPCO assumes the cost of returning products under warranty. NAPCO shall have no obligation under this warranty, or otherwise, if the product has been repaired by others, improperly installed, improperly used, abused, altered, damaged, subjected to accident, nuisance, flood, fire or acts of God, or on which any serial numbers have been altered, defaced or removed. NAPCO will not be responsible for any dismantling, reassembly or reinstallation charges.

This warranty contains the entire warranty. It is the sole warranty and any prior agreements or representations, whether oral or written, are either merged herein or are expressly cancelled. NAPCO neither assumes, nor authorizes any other person purporting to act on its behalf to modify, to change, or to assume for it, any other warranty or liability concerning its products.

In no event shall NAPCO be liable for an amount in excess of NAPCO's original selling price of the product, for any loss or damage, whether direct, indirect, incidental, consequential, or otherwise arising out of any failure of the product. Seller's warranty, as hereinabove set forth, shall not be enlarged, diminished or affected by and no obligation or liability shall arise or grow out of Seller's rendering of technical advice or service in connection with Buyer's order of the goods furnished hereunder.

NAPCO RECOMMENDS THAT THE ENTIRE SYSTEM BE COMPLETELY TESTED WEEKLY.

**Warning:** Despite frequent testing, and due to, but not limited to, any or all of the following; criminal tampering, electrical or communications disruption, it is possible for the system to fail to perform as expected. NAPCO does not represent that the product/system may not be compromised or circumvented; or that the product or system will prevent any personal injury or property loss by burglary, robbery, fire or otherwise; nor that the product or system will in all cases provide adequate warning or protection. A properly installed and maintained alarm may only reduce risk of burglary, robbery, fire or otherwise but it is not insurance or a guarantee that these events will not occur. CONSEQUENTLY, SELLER SHALL HAVE NO LIABILITY FOR ANY PERSONAL INJURY, PROPERTY DAMAGE, OR OTHER LOSS BASED ON A CLAIM THE PRODUCT FAILED TO GIVE WARNING. Therefore, the installer should in turn advise the consumer to take any and all precautions for his or her safety including, but not limited to, fleeing the premises and calling police or fire department, in order to mitigate the possibilities of harm and/or damage.

NAPCO is not an insurer of either the property or safety of the user's family or employees, and limits its liability for any loss or damage including incidental or consequential damages to NAPCO's original selling price of the product regardless of the cause of such loss or damage.

Some states do not allow limitations on how long an implied warranty lasts or do not allow the exclusion or limitation of incidental or consequential damages, or differentiate in their treatment of limitations of liability for ordinary or gross negligence, so the above limitations or exclusions may not apply to you. This Warranty gives you specific legal rights and you may also have other rights which vary from state to state.