

REMOTE ACCESSORIES

INSTALLATION INSTRUCTIONS FOR OUTSIDE SLIMLINE PLATE

- Using the template shown in Fig. 1, drill out the following holes on a convenient location near the entrance to the premises.
Holes A & B are used with each outside remote
Holes 1 & 2 are used with models 610/1210
Holes 1, 2 & 3 are used with models 521, 521D, 521M, 526, 621, 621M, 626, 1221, 1221M, 1226, 1213
- Carefully solder control wires as indicated (see model no.)
- Mount inner plate assembly to wall surface using the two #4 - 1/2" long self tapping screws provided, in "A" hole locations.
- Attach the face plate to the mounted inner plate assembly with the machine screws provided.

MODEL 600/650

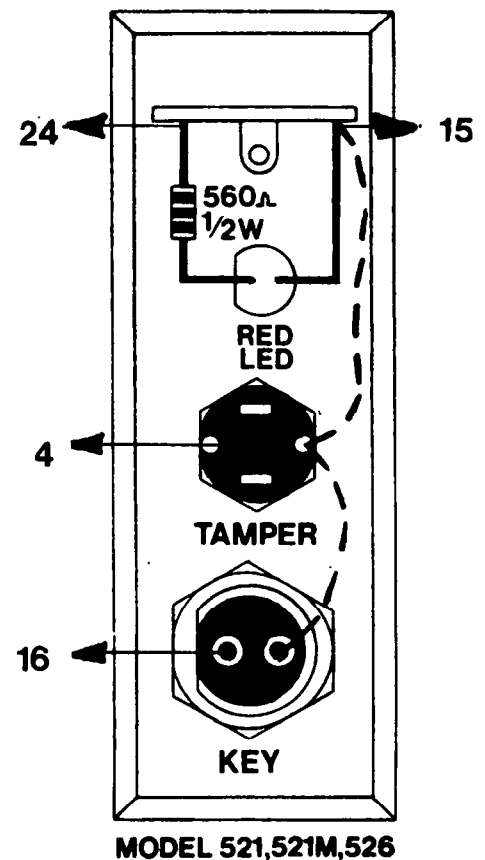
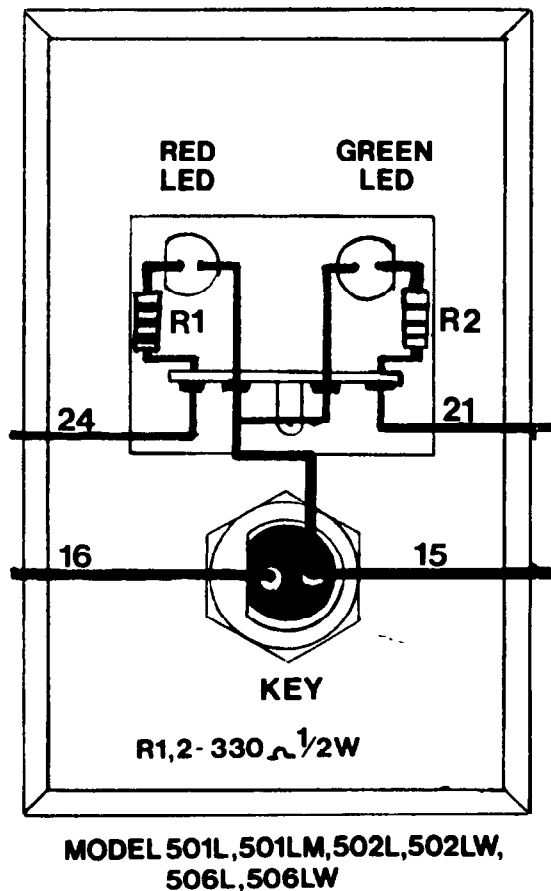
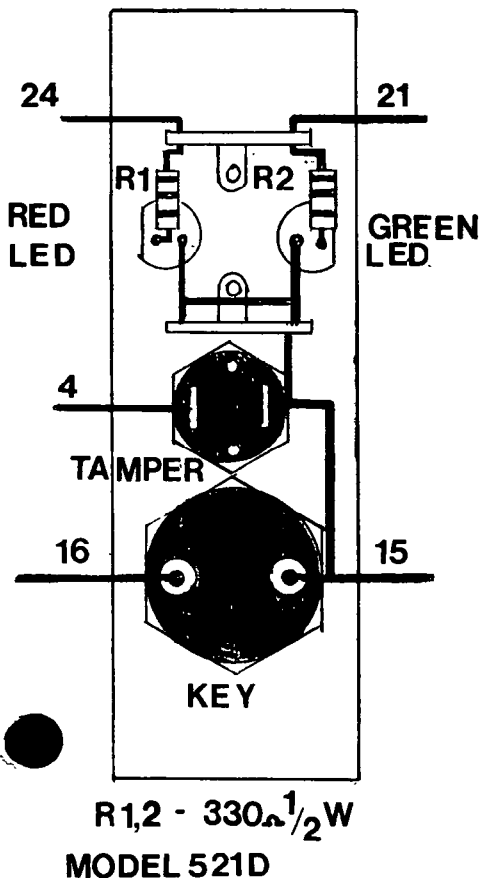

REMEMBER... "WE DO WHAT THEY DON'T"

ISSUE D
DATE 1/31/77

FIG1- DRILLING TEMPLATE

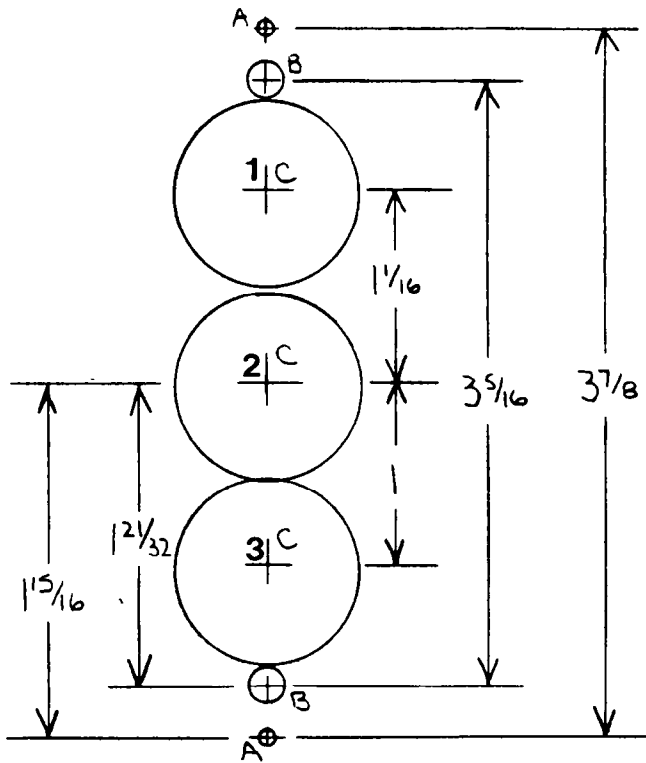

A" CENTERS - 1/16 DIAMETER PILOT HOLE
B" CENTERS - 3/16 DIAMETER CLEARANCE HOLES
C" CENTERS - 1" DIAMETER CLEARANCE HOLES

MODEL 675

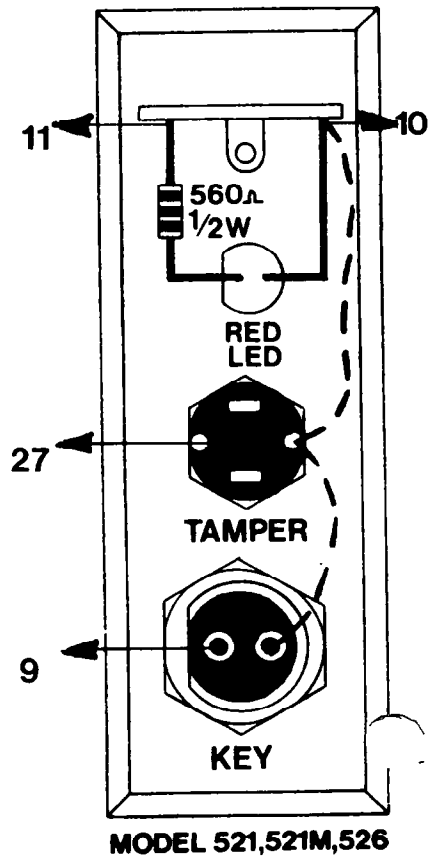
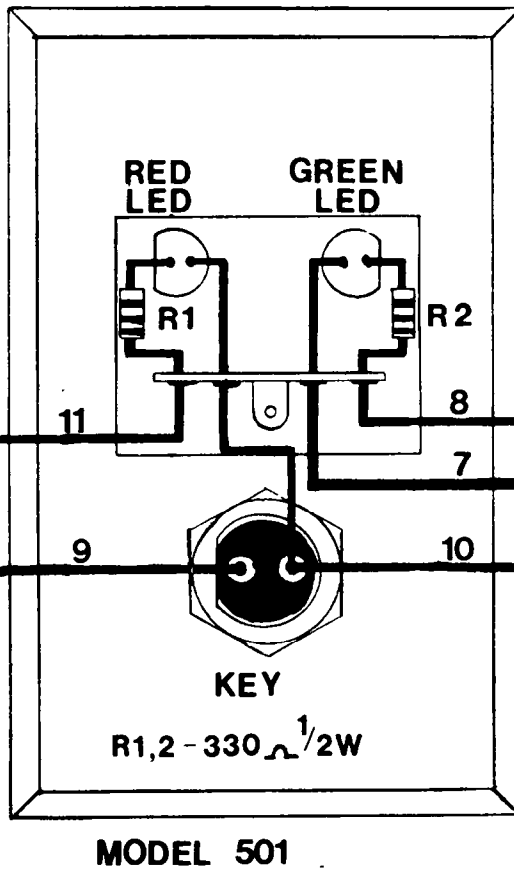
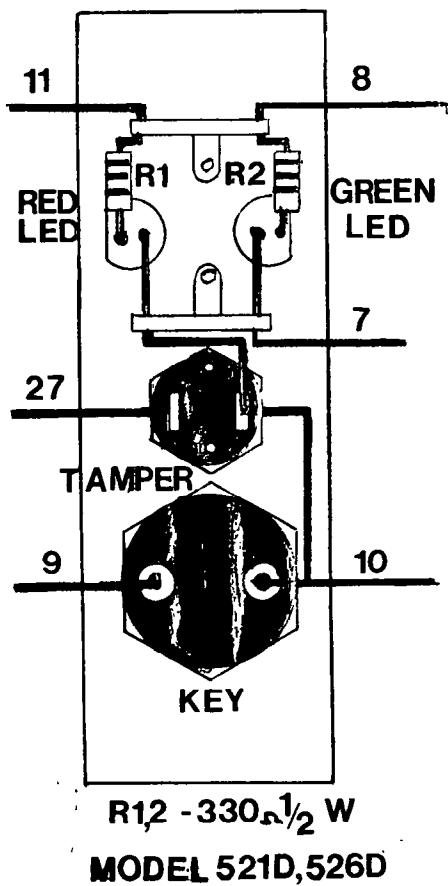

MODEL 604/654,1204/1254

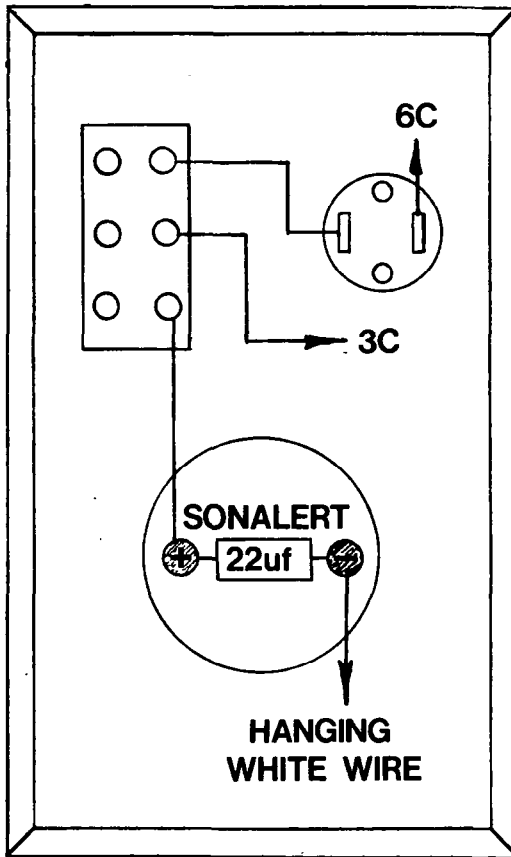
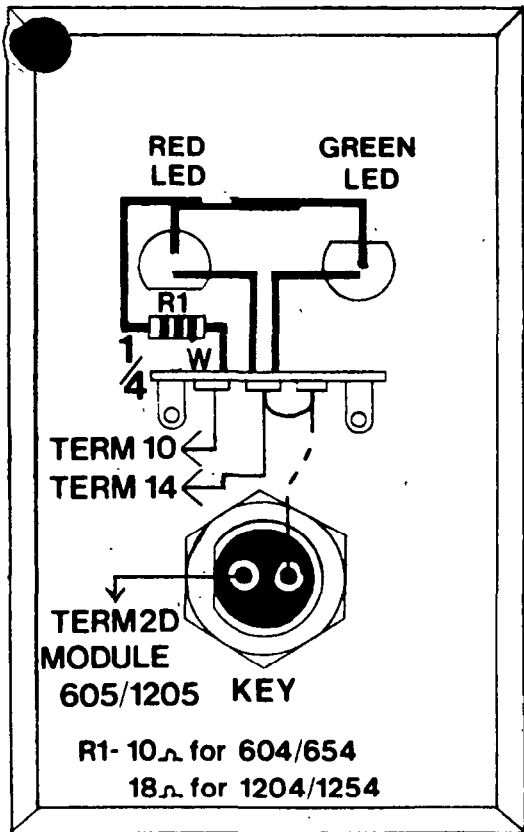

MODEL 676/1276

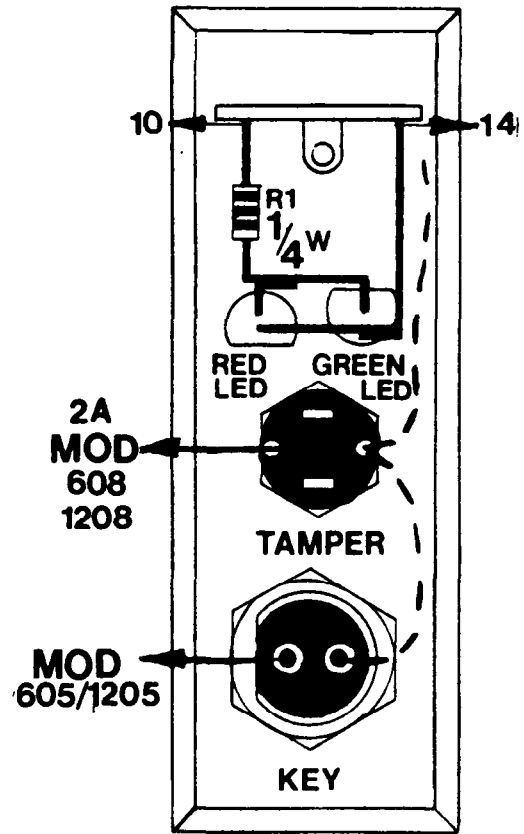

MODEL 621,621M,626,1221,1221M 1226, 610,1210- NO KEY HOOK-UP

MODEL 601W,601WM,602W,1201W,1201WM,1202W

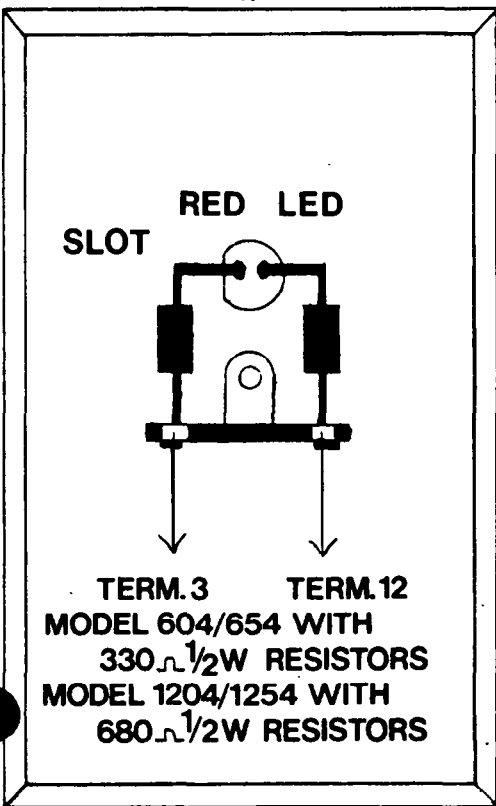

MODEL 609,1209

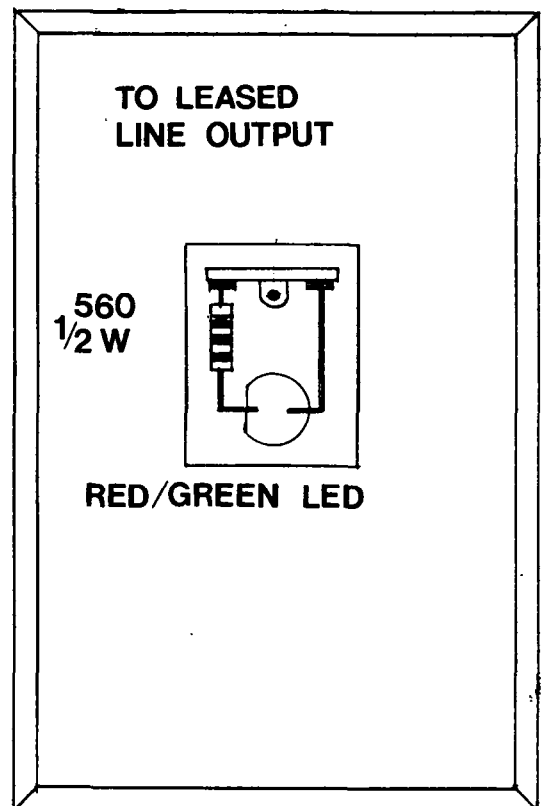

MODEL 884

MODEL 675

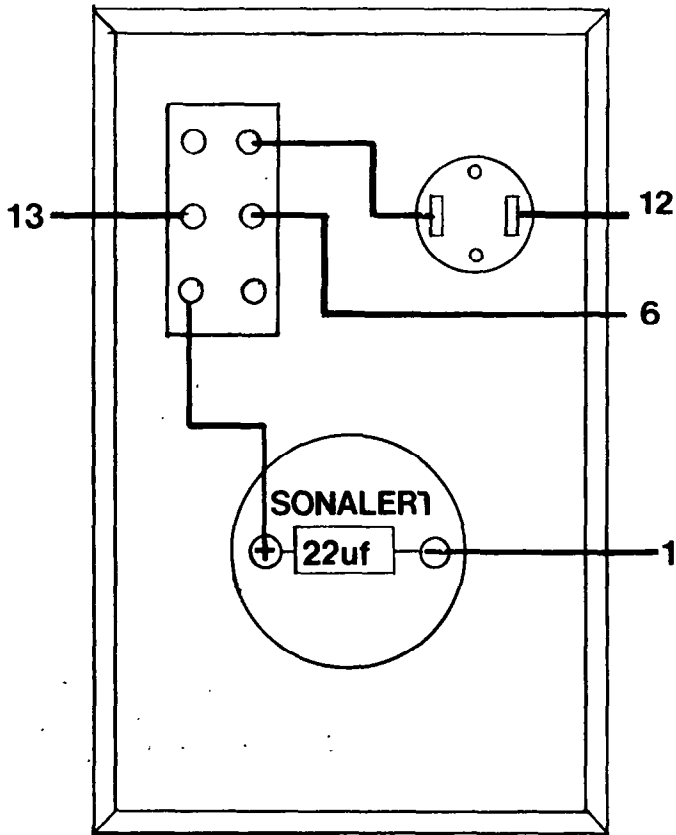

MODEL 676

MODEL 1200/1250

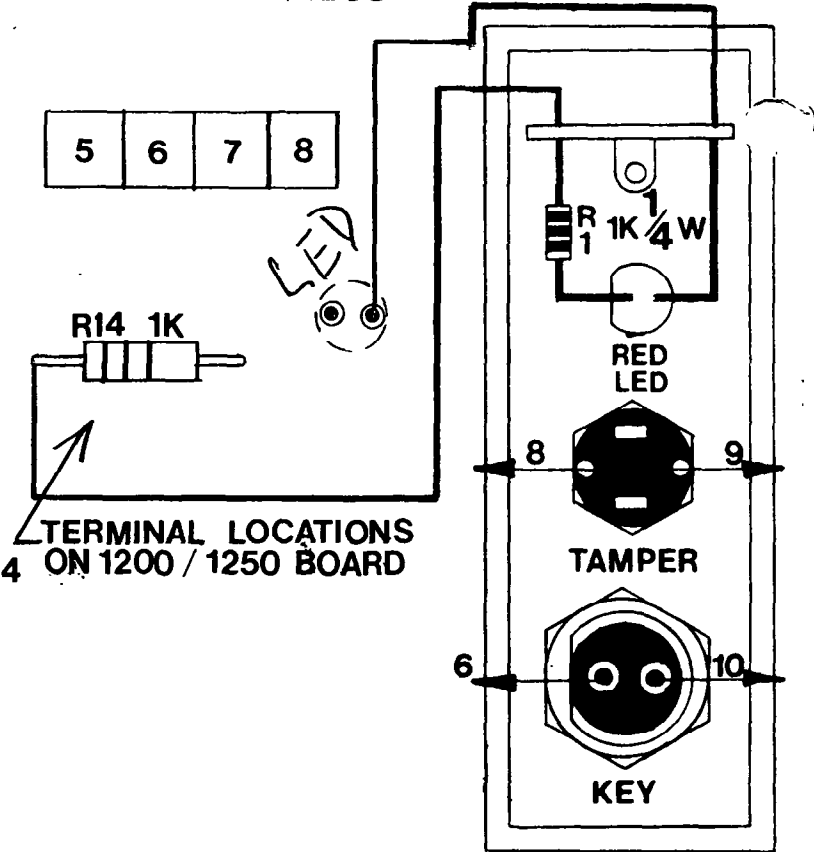

MODEL 1213

MODEL 1230

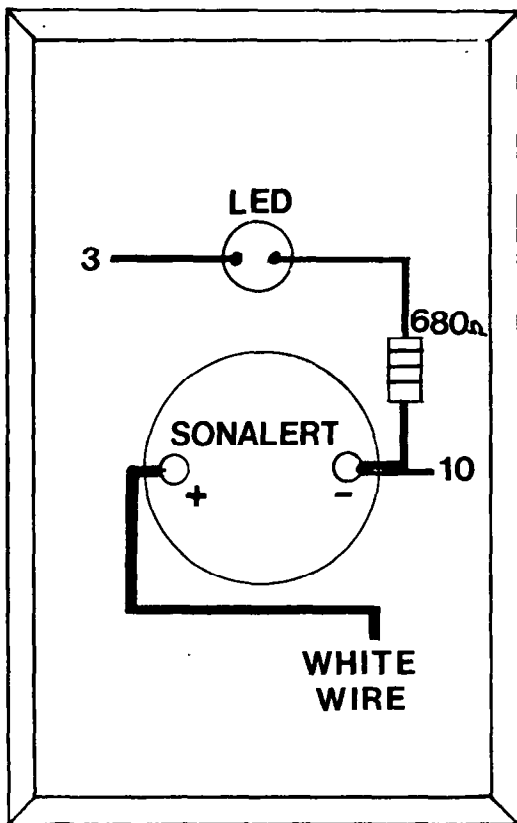

MODEL 1231

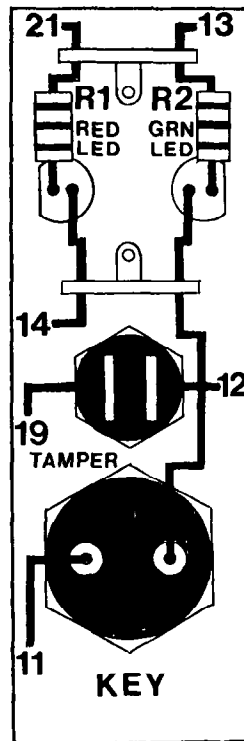

R1,2 - 330 Ω 1/2 W
MODEL 521D, 526D

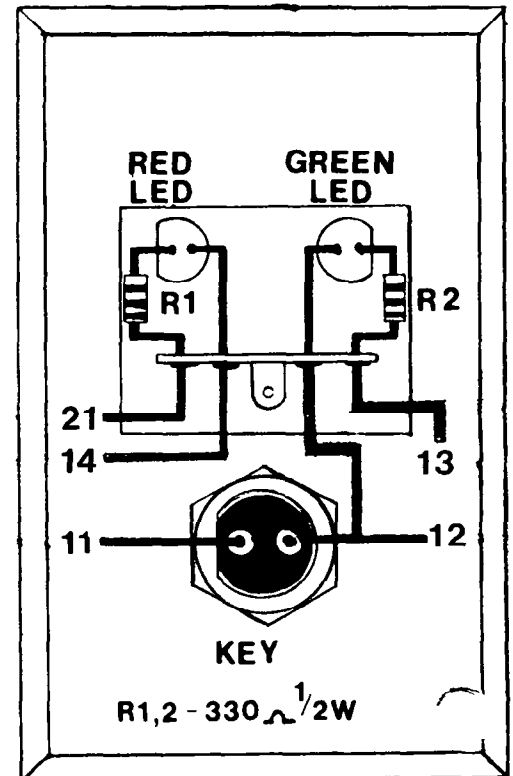

MODEL 501L